

Model: TEQ 3

Model life 2010>>

NR	Description
017	base equipment level
029	Standard chassis
092	Turbo S
098	Left-hand drive version
099	Right-hand drive version
176	Sports exhaust system
193	japan version
206	Electrically extendable trailer hitch
216	Trailer hitch preparation
249	Tiptronic transmission
250	PDK transmission (dual clutch)
258	Electrically retractable exterior mirrors
259	Electrically retractable ext. mirrors with memory
260	Electrically retractable exterior mirrors with automatic dimming
261	Electrically retractable exterior mirrors with automatic dimming and memory
288	Headlamp washer
345	Heated steering wheel
350	Air suspension
351	Air suspension with PDCC
354	Air suspension and PASM Comfort
355	Air suspension and PASM, PDCC Comfort
378	Sports seat, backrest shell, right, electrically adjustable
379	Power seat, left, 14-way
380	Power seat, right, 14-way
425	Rear window wiper
426	Without rear window wiper
450	Ceramic brake (PCCB)
456	Automatic distance control (ACC)
462	Comfort air pressure, 270 km/h
475	"PASM" electronic damper control
480	6-speed manual transmission
482	Tire Pressure Monitoring TPM, 433 MHz
483	315-MHz TPM, Tire Pressure Monitoring
490	Sound system "ASK"
524	Immobilizer, central locking, 433 MHz
525	Immobilizer, central locking, 315 MHz
537	Seat position control for comfort seat, left
538	Seat position control for comfort seat, right
549	Roof Transport System
585	Cupholder
603	Bi-Xenon and dynamic cornering light

Model: TEQ 3

Model life 2010>>

NR	Description
604	Bi-Xenon top and dynamic cornering light
619	Mobile phone preparation (BLUETOOTH) without console
620	Bi-Xenon plus dynamic cornering light, Black
625	"KESSY" Porsche Entry and Drive
626	Charging tray in rear
630	Interior light package
632	PDLs+ dynamic high beam
633	ParkAssist (front and rear) plus real Topview
636	Park distance control in front and rear
638	ParkAssist, front, rear and reversing camera
639	Sport Chrono package
640	Sport Chrono Plus package
641	electronic log book
672	PCM 3 Offroad navigation
674	"Vehicle Tracking System" preparation
680	BOSE sound package
682	Top Premium sound system
696	CD radio, Porsche CDR 31
818	Aluminium decorative inlays
821	Decorative inlays in Dark Walnut
822	Tineo decorative inlays
823	Decorative inlays in Anthracite Birch
824	Decorative inlays in Olive
838	Business package
840	Sports steering wheel (for PDK with paddle)
870	Universal multimedia interface
890	Folding table, left
891	Folding table, right
899	Isofix child-seat restraint on front passenger side
IY2	Model year period from week 45 to week 22
L0L	Left-hand drive version
L0R	Right-hand drive version
NZ0	without emergency call control unit
QR0	without compass/Sport Chrono/analogue clock
QR3	Analog clock on dashboard
QR5	Sport Chrono Package Plus
TI4	8-cylinder diesel engine, 4.0-litre
TS8	6-cylinder diesel engine, 3.0-litre
TV8	V6 biturbo 2.9-litre basic engine components
T1M	V8 biturbo 4.0-litre basic engine components
T7V	V6 TDI basic engine components
T9I	V6 turbo 3.0-litre basic engine components
XAF	Turbo aerokit
XAP	Sport Design Package (Aerokit)

Model: TEQ 3

Model life 2010>>

NR	Description
XAR	Sill covers
XAV	Aerokit, Turbo
XEP	Preparation for "Rear Seat Entertainment"
XLF	Sports exhaust system
XRW	Panamera Sport wheel, 20"
XYA	PDK selector lever (EXC)
0E1	Shorter wheelbase
0E2	Long wheelbase
0K0	Without alternative drive system
0K3	Hybrid propulsion system PHEV
1D7	Preparation for detachable trailer coupling
1U0	Without folding table
1U1	Rear retractable folding table
3GA	without cargo management
3V1	ACC High with Innodrive
3Z6	Without business package
3Z7	Business package
6W2	Number-plate holder, front, small (RoW)
6W4	Front number plate bracket, Japan
6W7	Number plate bracket, front, China
7K3	Tyre pressure monitoring (TPM) 433 MHz
7K4	Tyre pressure monitoring system 315 MHz
7Y0	No lane change assistant
7Y1	Lane change assist
73H	Industrial charging cable, CEE 32A/230V/6H
73K	Industrial charging cable, CEE 32A/400V/6H
73L	Infrastructure charging cable, fixed (USA)
77J	Navigation software Argentina
77K	Navigation software Chile
8A4	Ultrasound parking aid with Real Topview
8T3	Automatic distance control (ADC)
8X0	Without headlamp washer system
8X1	Headlamp washer system
9R1	Night vision system
9WM	Preparation for "Rear Seat Entertainment"
9WU	MIRRORLINK + RSE PREPARATION
9WY	MirrorLink with Smart RSE
002	China Panamera, basic, long
010	Panamera II 4S SPORT EDITION
015	Special model: Panamera 4 GTS
016	Special model: Panamera Turbo S
017	base equipment level
020	Panamera G1 II Turbo S Exclusive Series
021	Instrument cluster dials in Black/Silver
022	Black-coloured instrument dials, instrument cluster
023	Silver -coloured instrument dials, instrument

Model: TEQ 3

Model life 2010>>

NR	Description
	cluster
024	Version for Greece
025	Black-coloured instrument dials, stopwatch
026	Silver-coloured instrument dials, stopwatch
029	Standard chassis
030	Sports suspension
032	Touring suspension
033	Panamera Edition
034	Version for Italy
058	Impact absorbers, front and rear
060	Turkey version
061	Version for Great Britain
062	sweden version
063	Version Luxemburg
064	Version for Netherlands
065	Version for Denmark
066	Version for Norway
067	Version for Finland
068	PAP right-hand drive version
069	Other country version
071	EU country version
072	Version for Mexico
073	Version for Russia
074	PAP left-hand drive version
075	Chinese version
080	Fuel tank, 80-litre
081	Fuel tank, 100-litre
086	Korea version
092	Turbo S
098	Left-hand drive version
099	Right-hand drive version
111	Version for Austria
113	Version for Canada
114	Version for Taiwan
119	Version for Spain
124	Version for France
126	Control and indications in French lettering
127	Control and indications in Swedish lettering
130	Control and indications in English lettering
143	V6T 3.0 litre, low compression ratio
144	V6T 3.0 litre, high compression ratio
145	Compression variant
150	Operation with leaded gas
158	Emissions concept EU3, diesel with EOBD
159	Curbed engine, 155 kW/211 bhp
160	Emissions concept EU 4 w/o OBD
161	Emissions concept EU 4 with OBD

Model: TEQ 3

Model life 2010>>

NR	Description
162	Emissions concept LEV-2
164	Emissions concept ULEV 2
165	Emissions concept EU 5
167	Emissions concept EU4, ethanol
168	Emissions concept EU5, Japan (hybrid)
170	Acoustic package RoW
171	Acoustic package USA
172	Acoustic package PAP, China, Korea
176	Sports exhaust system
182	Hot country
186	Tailpipes, sports exhaust system Turbo S
193	japan version
194	Battery, 60 Ah
195	Battery, 70 Ah
196	Battery, 80 Ah
197	Stronger battery
198	Enhanced starter motor (1.7 kW)
199	Battery disconnection switch
200	95 Ah battery
201	105 Ah battery
206	Electrically extendable trailer hitch
209	Licence plate holder version 1
210	Licence plate holder version 2
211	Licence plate holder version 3
213	Ski bag
215	Version for Saudi Arabia
216	Trailer hitch preparation
218	Licence plate holder version 4
219	Differential
220	Locking differential 40 %
221	PTV Plus, el. controlled rear-diff. lock
225	Version for Belgium
230	Tyres ZR 18" (245/50, 275/45)
231	Tyres ZR 19" (255/45, 285/40)
232	Tyres ZR 20" (255/40, 295/35)
234	All-season ZR 20 Rolling resistance optimised
235	All Season tyres, ZR 19" (255/45, 285/40)
236	All-season tyres R19 (255/45, 285/40)
237	All-season tyres ZR 19"
249	Tiptronic transmission
250	PDK transmission (dual clutch)
255	Manually retractable exterior mirrors with memory
257	Manually retractable exterior mirrors, with automatic dimming and memory

Model: TEQ 3

Model life 2010>>

NR	Description
258	Electrically retractable exterior mirrors
259	Electrically retractable ext. mirrors with memory
260	Electrically retractable exterior mirrors with automatic dimming
261	Electrically retractable exterior mirrors with automatic dimming and memory
263	Left exterior mirror glass, flat
264	Left exterior mirror glass, convex
265	Left exterior mirror glass, aspherical
266	Automatic anti-dazzle door mirror
267	Automatically dimmable interior and door mirrors
268	Rain sensor
270	Door mirrors -flat - driver's side, electrically adjustable and heatable
271	Door mirrors -aspherical- driver's side, electrically adjustable and heatable
273	Door mirrors, electrically adjustable and heatable
274	Vanity mirror, illuminated
275	Manual anti-dazzle interior mirror
276	Automatic anti-dazzle interior mirror
277	Swiss version
284	Right exterior mirror glass, convex
285	Right exterior mirror glass, aspherical
288	Headlamp washer
301	Transmission ratio long
325	Version for South Africa/New Zealand
335	Automatic seat belt, 3-point, rear
338	Rear-wheel drive
339	All-wheel drive
340	Wheel rims painted in basic colour
342	Seat heating, left/right seat
343	Adjustable heated seats, front and rear
345	Heated steering wheel
350	Air suspension
351	Air suspension with PDCC
352	Electronic damper control for PASM and PDCC
354	Air suspension and PASM Comfort
355	Air suspension and PASM, PDCC Comfort
367	Standard seat, left, 8-way
368	Standard seat, right, 8-way
369	Standard seat, left
370	Standard seat, right

Model: TEQ 3

Model life 2010>>

NR	Description
375	Sports seat, backrest shell, left
376	Sports seat, backrest shell, right
377	Sports seat, backrest shell, left, electrically adjustable
378	Sports seat, backrest shell, right, electrically adjustable
379	Power seat, left, 14-way
380	Power seat, right, 14-way
381	Seat upholstery, standard
382	Soft seat upholstery, front and rear
383	Soft seat cushion pad in front
388	Sports bucket seat, left
389	Sports bucket seat, right
390	Sports seat, left, 18-way
391	Sports seat, right, 18-way
402	Carrera 3 wheel 18-inch
403	Carrera S wheel 19-inch
404	19" Turbo-1 wheel
405	Carrera Classic wheel 19-inch
406	Carrera GT wheel 19-inch/20-inch
407	SportDesign wheel 19-inch
410	18" Turbo-2/Panamera wheel
411	18-inch Carrera wheel -->2005 19-inch Carrera wheel 2012-->
413	Panamera S wheel, 18"
414	Carrera S Facelift 18" wheel
415	Panamera Turbo wheel, 19"
416	Panamera Design wheel, 19"
417	RS Spyder Design wheel, 20"
418	911 Turbo 2 wheel, 20"
419	Carrera S Facelift 19" wheel
421	Turbo 2 wheel, 19"
424	CD storage unit
425	Rear window wiper
426	Without rear window wiper
429	20" 911 Turbo III wheel
431	Multi-function steering wheel, touch + feel
432	19" Carrera wheel (6)
436	Panamera Sport Design wheel, 19"
437	Comfort seat, left, electrically adjustable
438	Comfort seat, right, electrically adjustable
440	Antenna diversity
441	Basic sound package
444	Anti-theft lock, wheel bolts "THATCHAM"
446	Concave wheel centers

Model: TEQ 3

Model life 2010>>

NR	Description
	with full-colour Porsche Crest
447	Emergency wheel
448	Brake pad; sport version
450	Ceramic brake (PCCB)
451	Multi-function steering wheel, Makassar Ebony, touch + feel
452	Multi-function steering wheel, Sycamore, touch + feel
453	Multi-function steering wheel, Carbon, touch + feel
454	Automatic speed control
456	Automatic distance control (ACC)
457	Lane change assist
458	Lane departure warning
459	3-spoke airbag steering wheel, touch + feel
460	20" RS Spyder Design wheel
461	External antenna
462	Comfort air pressure, 270 km/h
463	Comfort air pressure, 100 mph
464	Komfortluftdruck Lowspeed USA
465	Rear fog light, left
466	Rear fog light, right
471	19" Panamera Turbo II wheel
472	19" Panamera Design II wheel
475	"PASM" electronic damper control
476	Porsche Stability Management (PSM)
479	Version for Australia
480	6-speed manual transmission
482	Tire Pressure Monitoring TPM, 433 MHz
483	315-MHz TPM, Tire Pressure Monitoring
484	Version for USA
488	Inscriptions in German language
490	Sound system "ASK"
492	Headlights for left-hand traffic
498	Deletion of model designation on rear end
499	Version for Germany
501	Car cover
509	Fire extinguishers
513	Lumbar support, right seat
516	Rear spoiler in Black
519	Rear spoiler in Silver
521	Tilt sensor
523	Immobiliser, 434 MHz
524	Immobilizer, central locking, 433 MHz
525	Immobilizer, central locking, 315 MHz
532	Alarm system remote control omitted
533	Radio convertible-top operation omitted
534	Theft security system, 433 MHz

Model: TEQ 3 Model life 2010>>

NR	Description
535	Theft security system, 315 MHz
536	-07 Alarm siren and tilt sensor 08- Alarm siren
537	Seat position control for comfort seat, left
538	Seat position control for comfort seat, right
539	Mechanical seat height adjustment, left
540	Mechanical seat height adjustment, right
541	Active seat ventilation (incl. heated seats)
542	Active seat ventilation, front and rear (incl. heated seats)
544	Anti-theft protection without infrared monitoring, 433 MHz
545	Anti-theft protection without infrared monitoring, 315 MHz
549	Roof Transport System
553	Version for USA, Canada
555	Black seat belts
556	Seat belts in basic colours
560	Advanced airbag
562	Airbag, driver's side and front passenger's side
563	Side airbag
565	Thorax airbag in rear seat backrest
566	Front fog lights, white
567	Windscreen tinted, upper part darker coloured
568	Windscreen without shade band
569	Standard sill covers, painted
571	Activated charcoal filter
572	Manual air-conditioning system
573	Air conditioner
574	No air conditioning
575	Luggage compartment cooling system
576	4-zone air conditioning system
581	Centre console, front
585	Cupholder
586	Lumbar support, left seat
592	Standard rooflining, fabric
594	Alcantara rooflining
597	Door sill trims, brushed aluminium
598	Door entry guards, brushed aluminium
600	Bi-Xenon
601	Xenon lighting system
602	LED headlights with dynamic cornering light Plus (PDLS Plus)

Model: TEQ 3

Model life 2010>>

NR	Description
603	Xenon plus dynamic cornering light
604	Bi-Xenon top and dynamic cornering light
605	LED daytime driving lights
606	Daytime driving lights
607	Garage door opener "Homelink", 315 MHz
608	Garage door opener "Homelink" 433 MHz
610	DVD navigation, "Europe package"
611	DVD navigation South Africa
612	DVD navigation middle east
613	DVD navigation australia
614	DVD navigation asia-pacific
615	DVD navigation system, North America
616	DVD, Navigation Russia
617	DVD Navigation China
618	Phone preparation
619	Mobile phone preparation (BLUETOOTH) without console
620	Bi-Xenon plus dynamic cornering light, Black
621	12-V socket, passenger's side, footwell
625	"KESSY" Porsche Entry and Drive
626	Charging tray in rear
627	Bi-Xenon/static AHBA
630	Interior light package
631	Traffic sign recognition
632	PDLs+ dynamic high beam
633	ParkAssist (front and rear) plus real Topview
634	ParkAssist (front and rear) with camera (LOW)
635	Park distance control
636	Park distance control in front and rear
637	Rear ParkAssist and reversing camera
638	ParkAssist, front, rear and reversing camera
639	Sport Chrono package
640	Sport Chrono Plus package
641	electronic log book
642	Start/Stop function
644	Central locking button in rear
645	Master control button in rear (seat adjustment)
647	Steering column, mechanically reach/height-adjustable, without ELV
648	Steering column, electrically reach/height-adjustable, without ELV
650	Electrical sliding roof
651	Electric window opener

Model: TEQ 3 Model life 2010>>

NR	Description
652	Without sliding/tilting roof
655	Steering column with mech. reach/height adjustment
656	Steering column with electric reach/ height adjustment and memory
657	Power steering
658	Servotronic
659	on-board computer
660	Obd 2
661	Stricter emission-control concept
663	Fuel pump activation
664	Orvr
665	-2008 PCM 2, 2009- PCM 3 basic module incl. radio
666	-2008 PCM 2, 2009- PCM 3 telephone (GSM)
669	PCM 3 - Telephone handset (BLUETOOTH)
671	Voice control system
672	-2008 PCM 2, 2009- PCM 3 Offroad navigation
673	Navigation system preparation, China
674	"Vehicle Tracking System" preparation
675	Without radio preparation (Japan navigation system)
676	TV tuner
677	"Driver card" antenna
678	Alarm system connection
679	Restart inhibitor
680	BOSE sound package
682	Top Premium sound system
685	Rear seats, split
686	SAT radio reception XM (SDARS)
688	HD radio reception
689	Preperation for CD autochanger
690	CD radio "Porsche Online Pro"
691	Digital radio reception DAB
692	CD autochanger "Porsche"
693	Integrated CD/DVD autochanger
694	CD radio "PORSCHE CDR 24"
695	CD radio, Porsche CDR 30
696	CD radio, Porsche CDR 31
697	CD radio "Porsche CDR-23"
701	Springs of the next lowest weight group
750	Model year A -(2010) vehicle with technical design status Electric Model year B (2011)-
789	Colour to sample
796	Full leather trim natural leather
798	Full leather trim special leather
799	Full leather trim by choice
801	Makassar Ebony wood package, dark (matt satin finish)

Model: TEQ 3

Model life 2010>>

NR	Description
802	Sycamore package, light (matt satin finish)
803	Carbon package
805	Lifestyle package
806	Aluminium package, Black (Blackline)
810	foot mats
817	Decorative inlays in Piano Black
818	Aluminium decorative inlays
819	Carbon decorative inlays
821	Decorative inlays in Dark Walnut
822	Tineo decorative inlays
823	Decorative inlays in Anthracite Birch
824	Decorative inlays in Olive
826	Decorative inlays in American Walnut
827	Decorative inlays in American Walnut/Piano Black
830	Basic rear seats (40/60), Comfort
831	Basic rear seats (40/60), Sport
832	Premium rear seats (40/20/40), Comfort
833	Premium rear seats (40/20/40), Sport
834	Premium rear seats (40/20/40), Comfort electric
835	Premium rear seats (40/20/40), Sport electric
836	Premium rear seats (40/40), Business
837	Multi-function steering wheel in Walnut
838	Business package
840	Sports steering wheel (for PDK with paddle)
841	Basic steering wheel Smooth leather
842	Multi-function steering wheel, Dark Walnut
843	Sports steering wheel in Alcantara
844	Multi-function steering wheel Smooth leather
845	Multi-function steering wheel Carbon
847	Multi-function steering wheel Makassar
848	Multi-function steering wheel, Anthracite Birch
849	Multi-function steering wheel, Tineo
850	Auxiliary/additional heater w/o remote control
851	Auxiliary/additional heater with remote control
852	PDLs+ High beam assist
856	5-mm wheel spacers, rear
861	Electric roll-up blind, rear side windows
862	Electric roll-up blind on rear window
863	Tinted heat-insulating glass
864	"Privacy" heat-insulating glass
865	"Clear" heat-insulating glass

Model: TEQ 3 Model life 2010>>

NR	Description
866	"Privacy" heat-insulating glass
867	Trunk lid power closing
868	Roll-up blind for luggage compartment cover
869	Rear shelf (fixed luggage cover)
870	Universal multimedia interface
874	Horns for extreme driving situations
885	Softclose (closing aid for doors)
890	Folding table, left
891	Folding table, right
899	Isofix child-seat restraint on front passenger side
911	Model designation 911
912	without identification plate
932	Rear seat covers in Alcantara/leather
936	Seat covers, rear, leather
937	Seat covers, rear, leatherette
938	Seat covers rear, leather/leather/leatherette Partially embossed
939	Seat covers, rear, draped leather
940	Seat covers rear, ruff.leather/leather/leatherette Soft ruffled leather, embossed
941	Seat covers rear, ruffled leather/leather/leather Soft ruffled leather, smooth finish
943	Seat covers rear, leather/leather/leather Full-leather, smooth finish
946	Seat covers, front, leather/leather/leatherette
947	Seat covers fr., ruff.leather/leather/leatherette Soft ruffled leather, embossed
950	Alcantara seat covers, front
951	Seat covers front, Alcantara/leather/leather
970	Two-tone interior
971	"TORO" embossed leather
975	Alcantara interior
980	Leather package
981	Leather equipment, without seat covers
982	Seat covers, front, draped leather/leather/leather
983	Seat covers, front, leather
985	Seat covers, leather/leather/leatherette, 2
990	Seat covers, front, cloth/cloth/leatherette
991	Steering wheel airbag module in leather
998	Leather, natural
999	Passenger compartment monitoring sensor for leather colour of choice

Model: TEQ 3

Model life 2010>>

NR	Description
B0M	Component set for AGCC countries
B1D	Component set for Brazil
DJ5	6-Zylinder-Dieselmotor 3,0 L/220 KW TDI
D51	6-Zylinder-Dieselmotor 3,0 L/184 KW TDI
EH1	Length of charging cable: standard
EH2	Charging cable length: 7.5 metres
ES1	Charging socket, AC type 1, mode 2-3 (NAR/Japan)
ES3	Charging socket, AC type 2, mode 2-3 (EU)
ES4	Household charging socket, type L
ET0	Household charging cable, type L
EV1	Household charging cable, type E/F
EV2	Household charging cable, type Japan 100V
EV3	Household charging cable, type J
EV4	Household charging cable, type G
EV5	Household charging cable, type B
EV6	Household charging cable, type K
EV7	Household charging cable, type I Australia
EV8	Household charging cable, type M
EV9	Household charging cable, type I CN China
IY1	Model year period from week 22 to week 45
IY2	Model year period from week 45 to week 22
J0B	Battery (92 Ah) Battery (92 Ah)
KB1	Charger, 3.6 kW
KB2	Charger, 7.2 kW
K8D	Sport Turismo
L0L	Left-hand drive version
L0R	Right-hand drive version
NJ1	Charging Dock (wall mount)
NJ2	Charging Dock, flush-mounted (wall mount)
NZ0	without emergency call control unit
QR0	without compass/Sport Chrono/analogue clock
QR3	Analog clock on dashboard
QR5	Sport Chrono Package Plus
Q1G	Standard seats (front), 8-way
TI4	8-cylinder diesel engine, 4.0-litre
TV8	V6 biturbo 2.9-litre basic engine components
T1M	V8 biturbo 4.0-litre basic engine components
T7V	V6 TDI basic engine components
T9I	V6 turbo 3.0-litre basic engine components
UX5	Standard valve
UX6	TPM valve, Silver
UX7	TPM valve, Black
XAF	Turbo aerokit
XAJ	Painted sill covers
XAP	Sport Design Package (Aerokit)
XAR	Sill covers
XCA	Dashboard trim strip (3-part) sports seats

Model: TEQ 3

Model life 2010>>

NR	Description
XCB	Instrument surround sports seats
XCC	Side air vents sports seats
XCD	Center air vent bracket sports seats
XCE	Rear center console sports seats
XCG	Sports seat backrest in Aluminium Look finish
XCH	Side/centre air vent slats, sports seats
XCK	Rear center console in Galvano Silver
XCL	Instrument surround in Galvano Silver
XCN	Side air vents in Aluminium Look finish (997)
XCY	Center air vent in Aluminium Look finish
XCZ	Short shifter
XDG	Rims painted in high-gloss Black
XDS	Ignition lock surround in leather
XDV	Dashboard end-trim in leather
XDZ	Selector lever cover in leather
XD9	Wheel painted in body colour
XEA	Passive handset in leather
XEP	Preparation for "Rear Seat Entertainment"
XES	Preparation, illuminated door entry guard
XET	Preparation for coolbox in rear
XEX	Headlights, Black
XEY	LED headlights, dynamic Cornering light
XE8	Gear lever knob aluminium/dark burr maple/leather
XE9	Handbrake lever aluminium/dark burr maple/leather
XFD	Instrument dials in Sand Beige
XFE	Instrument dials in Terracotta
XFF	Instrument dials in Brown/Natural
XFG	Instrument dials in Guards Red
XFH	Instrument dials in Speed Yellow
XFJ	Instrument dials in Carrara White
XFL	Instrument dials painted in Luxor Beige
XFY	20" Panamera Sport wheel, Platin.
XGB	Decorative dashboard trim, carbon
XGC	Dashboard carbon/Alcantara
XGE	Handle recess insert, carbon
XHA	Decorative inlays, leather
XJL	Makassar Ebony side air vent
XJM	Sycamore side air vent
XJN	Makassar Ebony center air vent
XJP	Sycamore center air vent
XJR	Makassar Ebony windscreen defroster panel
XJS	Sycamore windscreen defroster panel
XJT	Makassar Ebony rear center console
XJU	Sycamore rear center console
XJ4	Leather cover for ignition lock surround
XKB	Side air vent in light burr maple

Model: TEQ 3

Model life 2010>>

NR	Description
XKC	Side air vent in dark burr maple
XKD	Side air vent in Carbon
XKG	"Defroster trim in light burr maple; leather"
XKH	"Defroster trim in dark burr maple; leather"
XKJ	Defroster trim in Carbon/leather
XKL	Leather speaker covers
XKM	Speaker covers in light burr maple
XKN	Speaker covers in dark burr maple
XKP	Carbon speaker covers
XKR	Center air vent bracket in light burr maple
XKS	Center air vent bracket in dark burr maple
XLF	Sports exhaust system
XLG	Centre console storage bin cover in Alcantara, with logo
XLP	Sports tailpipes, Black
XLR	Sports tailpipes, Panamera
XMA	Rooflining in leather
XME	Rear section of centre console painted
XMF	Front center console including 2 storage bins, leather
XMJ	Rear section of centre console in Carbon
XML	Rear center console in light burr maple
XMP	Leather sun visor, 2 illuminated vanity mirrors *
XMR	Sun visor in leather, 2 illuminated vanity mirrors,
XMZ	Rear section of centre console in leather
XNB	Rear center console in dark burr maple
XNG	Instrument surround in leather
XNN	Center air vent bracket in leather
XNR	Carbon center air vent bracket
XNS	Leather steering column trim, 4-part
XNU	Leather trim strip (dashboard)
XNV	Trim strip (dashboard) in light burr maple
XNW	Trim strip (dashboard) in dark burr maple
XNX	Carbon trim strip (dashboard)
XN3	Dashboard side air vent in leather
XPA	3-spoke sports steering wheel in leather interior co
XPB	3-spoke sports steering wheel, light burr maple, leather
XPC	3-spoke sports steering wheel, dark burr maple, leather
XPD	3-spoke sports steering wheel, Carbon/leather
XPG	3-spoke sports steering wheel, sports seats
XPT	Centre console storage bin lid with crest
XPU	Multi-function steering wheel Galvano Silver, new generation
XPV	Multi-function steering wheel, Galvano Silver

Model: TEQ 3

Model life 2010>>

NR	Description
XPW	Instrument surround in light burr maple
XPX	Instrument surround in dark burr maple *
XPY	Carbon instrument surround
XRB	18-inch Sport Classic II wheel
XRC	18-inch SportTechno wheel
XRL	18-inch SportDesign wheel
XRN	17-mm spacers, rear
XRP	5-mm spacers, front/rear
XRR	19-in. Carrera Sport wheel
XRU	20" Sport Classic wheel
XRV	20" Sport Classic wheel, Jet Black
XRW	Panamera Sport wheel, 20"
XRX	Panamera Sport wheel 20" in body colour
XRY	Panamera Sport wheel 20" in Black
XRZ	20" Sport Classic wheel, Black
XSA	Painted sports seat backrest
XSB	Leather sports seat backrest
XSC	Porsche Crest embossed in headrest
XSD	Front seat controls in leather
XSE	Bucket seat, left
XSF	Bucket seat, right
XSH	Silver seat belts
XSM	Racing safety cage
XSN	Omission of rear seats
XSR	Carbon back for bucket seat, right
XSS	Carbon back for bucket seat, left
XST	Seat belts in Sand Beige
XSU	Upholstered seat
XSW	Seat belts in Maritime Blue
XSX	Seat belts in Guards Red
XSY	Seat belts in Speed Yellow
XTG	Inner door sills in leather
XTJ	Door panel parts in light burr maple
XTK	Door panel parts in dark burr maple
XTL	Door panel parts in Carbon
XTR	Door panel parts in Aluminium Look finish
XTT	Makassar Ebony door panel parts
XTU	Sycamore door panel parts
XTV	Leather door panel parts
XTW	Door panel parts in Galvano Silver
XUB	Cover on headlight cleaning system, painted
XUF	SportDesign rear apron
XUL	SportDesign rear apron, painted Black *

Model: TEQ 3

Model life 2010>>

NR	Description
XUV	Centre console storage bin lid with logo
XVM	Leather center air vent
XVP	Trim strip including cupholder cover in leather
XVR	Side/centre air vent in leather
XV1	Defroster trim in leather
XWR	PDK gate frame in Aluminium Look
XWS	PDK gate frame painted
XWT	PDK gate frame painted Black
XWU	PDK gate frame in leather
XXB	Door entry guards, stainless steel, illuminated
XXC	Door entry guards, aluminium, illuminated
XXD	Door entry guards, carbon, illuminated
XXF	Red tail lights
XXP	Tail lights, darkened
XXV	Sports-look pedals
XXZ	Footrest
XX1	Floor mats, logo, leather border
XX2	footwell light
XYA	PDK selector lever (EXC)
XYB	Fuel tank cap in Aluminium Look
XYR	Porsche Crest on armrest front
XYS	Model logo on armrest front
XYT	Porsche Crest on armrest front and rear
XYU	Model logo on armrest front and rear
XYV	Porsche Crest on front headrest
XYW	Porsche Crest on front and rear headrests
XZB	Carbon centre air vent
XZD	Interior light surround in leather
XZY	Decorative inlays in Mahogany Yachting
XZZ	Multi-function steering wheel, Mahogany Yachting
X45	Instrument dial in interior color
X47	Gear lever knob in Carbon/leather
X54	Stainless steel tailpipes
X69	Door entry guards in Carbon with logo
X70	Door entry guards in stainless steel with logo
X71	Instrument dial painted/Aluminium Look finish
X72	Gear lever knob aluminium/light burr maple/leather
X73	Turbo sports suspension
X74	Sports suspension (exclusive)
X75	Differential lock (exclusive)
X76	Inner door sill guard, left/right
X80	Panamera Turbo power kit
X97	Gear lever knob in aluminium/leather

Model: TEQ 3 Model life 2010>>

NR	Description
X99	Natural leather
0E1	Shorter wheelbase
0E2	Long wheelbase
0K0	Without alternative drive system
0K3	Hybrid propulsion system PHEV
0Y1	Standard climatic zone
0Y2	Tropical climatic zone
0Y3	Cold climatic zone
1A5	Engine variant with reduced compression
1D7	Preparation for detachable trailer coupling
1U0	Without folding table
1U1	Rear retractable folding table
3GA	without cargo management
3L4	Driver memory package
3L5	Electrical adjustment for both 12-way adjustable front seats
3L6	Front seat adjustment, electrical with memory, right
3PB	Front seat adjustment, left electrical, right manual
3PH	Front seat adjustment, right electrical and memory, left manual
3V1	ACC High with Innodrive
3Z6	Without business package
3Z7	Business package
4F2	Porsche entry + drive
4F6	Porsche entry + drive (usa/can)
4K0	Central-locking system with key remote and interior operation
4K3	Central locking with remote control, inner release and safe lock system
4SV	Vanity mirror in rear left
4TV	Vanity mirror in rear right
6W2	Number-plate holder, front, small (RoW)
6W4	Front number plate bracket, Japan
6W7	Number plate bracket, front, China
7G9	VTS preparation and Porsche Car Connect (pcc)
7I2	VTS security package (with PCC)
7K3	Tyre pressure monitoring (TPM) 433 MHz
7K4	Tyre pressure monitoring system 315 MHz
7MM	EU6 plus exhaust concept
7Y0	No lane change assistant
7Y1	Lane change assist
70A	Weight group 1, front axle (-950 kg)
70B	Weight group 2, front axle (951-965 kg)

Model: TEQ 3 Model life 2010>>

NR	Description
70C	Weight group 3, front axle (966-980 kg)
70D	Weight group 4, front axle (981-995 kg)
70E	Weight group 5, front axle (996-1025 kg)
70F	Weight group 6, front axle (1026-1055 kg)
70G	Weight group 7, front axle (1056-1070 kg)
70H	Household charging cable, type N Brazil
70L	Household charging cable, type N ZA South Africa
71A	Weight group 1, rear axle (-880 kg)
71B	Weight group 2, rear axle (881-905 kg)
71C	Weight group 3, rear axle (906-930 kg)
71D	Weight group 4, rear axle (931-960 kg)
71E	Weight group 5, rear axle (961-990 kg)
71F	Weight group 6, rear axle (991-1020 kg)
71G	Weight group 7, rear axle (1021-1050 kg)
71Z	Without weight group specification Rear axle
73B	Industrial charging cable, NEMA 6-30
73C	Industrial charging cable, NEMA 6-50
73D	Industrial charging cable, type NEMA 14-30
73E	Industrial charging cable, NEMA 14-50
73F	Industrial charging cable, Japan 200V
73G	Industrial charging cable, CEE 16A/230V/6H
73H	Industrial charging cable, CEE 32A/230V/6H
73J	Industrial charging cable, CEE 16A/400V/6H
73K	Industrial charging cable, CEE 32A/400V/6H
73L	Infrastructure charging cable, fixed (USA)
77J	Navigation software Argentina
77K	Navigation software Chile
8A4	Ultrasound parking aid with Real Topview
8T3	Automatic distance control (ADC)
8X0	Without headlamp washer system
8X1	Headlamp washer system
9G1	220 A generator

Model: TEQ 3

Model life 2010>>

NR	Description
9R1	Night vision system
9WU	MIRRORLINK + RSE PREPARATION
9Z2	Plug socket, 115 V/60 HZ
9Z3	Plug socket, 230 V/50 HZ
9Z4	Plug socket, 100 V/50 HZ

Model: TEQ 3

Model life 2010>>



Model: TEQ 3 Model life 2010>>

Pos	Part Number	Description	Remark	Qty	Model
1	000 044 001 13	Hi-visibility vest Bodywarmer Hi-visibility vest set		1	- "USA" , - "CDN"

Model: TEQ 3

Model life 2010>>



Model: TEQ 3

Model life 2010>>

Pos	Part Number	Description	Remark	Qty	Model
1	955 044 001 00	tool kit bag tool bag with tools Leather		1	

Model: TEQ 3

Model life 2010>>

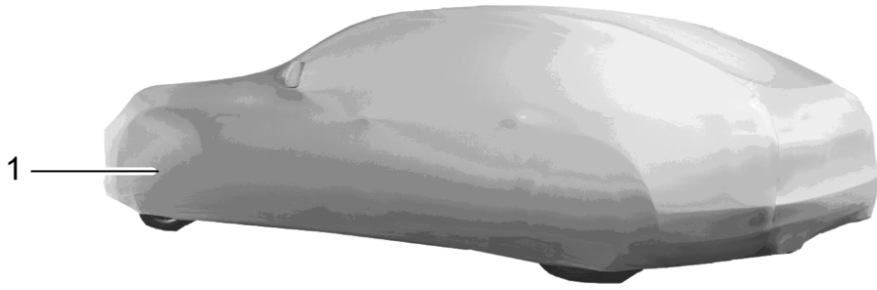

Model: TEQ 3 Model life 2010>>

Pos	Part Number	Description	Remark	Qty	Model
1	971 044 020	Cover D - MJ 2010>> Cover Indoor		1	PR:0E1
(1)	971 044 022	D - MJ 2017>> Cover Indoor		1	PR:0E2
(1)	971 044 024	D - MJ 2017>> Cover Indoor		1	SportTurismo
(1)	970 044 000 32	D - MJ 2017>> Cover Indoor		1	PR:0E1
(1)	970 044 000 34	D - MJ 2010>> Cover Indoor		1	PR:0E2
2	971 044 021	D - MJ 2014>> Cover Outdoor		1	PR:0E1
(2)	971 044 023	D - MJ 2017>> Cover Outdoor		1	PR:0E2
(2)	971 044 025	D - MJ 2017>> Cover Outdoor		1	SportTurismo
2	970 044 000 31	D - MJ 2017>> Cover Outdoor		1	alle
(2)	970 044 000 33	D - MJ 2010>> - MJ 2013 Cover Outdoor		1	PR:0E1
(2)	970 044 000 35	D - MJ 2014>> Cover Outdoor D - MJ 2014>>		1	PR:0E2

Model: TEQ 3

Model life 2010>>



Model: TEQ 3 Model life 2010>>

Pos	Part Number	Description	Remark	Qty	Model
1	991 044 000 50	Luggage set Exclusive programme Luggage set (complete) Exclusive programme Leather Black With coloured stitching gold 4-part		1	
(1)	991 044 000 60	Luggage set (complete) Exclusive programme Leather Black With coloured stitching silver 4-part		1	
-	991 044 000 61	Pocket Size xl Exclusive programme Leather Black With coloured stitching silver		1	
-	991 044 000 62	Pocket Size l Exclusive programme Leather Black With coloured stitching silver		1	
-	991 044 000 63	Pocket Size S Exclusive programme Leather Black With coloured stitching silver		1	
-	991 044 000 64	Clothes bag Exclusive programme Leather Black With coloured stitching silver		1	

Model: TEQ 3

Model life 2010>>

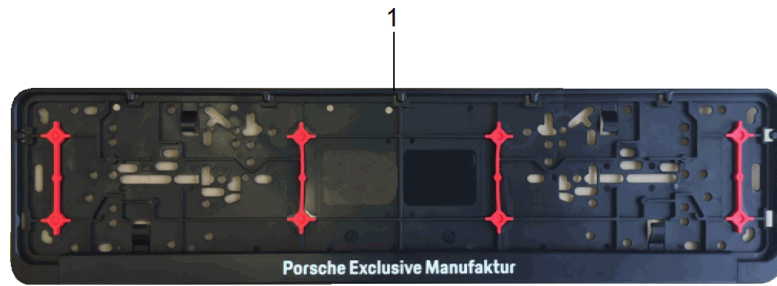

P96006000 05 - 18

Model: TEQ 3

Model life 2010>>

Pos	Part Number	Description	Remark	Qty	Model
1	991 044 804 00	Licence plate holder EXCLUSIVE MANUFAKTUR Carrier Licence plate holder EXCLUSIVE MANUFAKTUR	1-part EU-28 520MM X 110MM	1	

Model: TEQ 3

Model life 2010>>

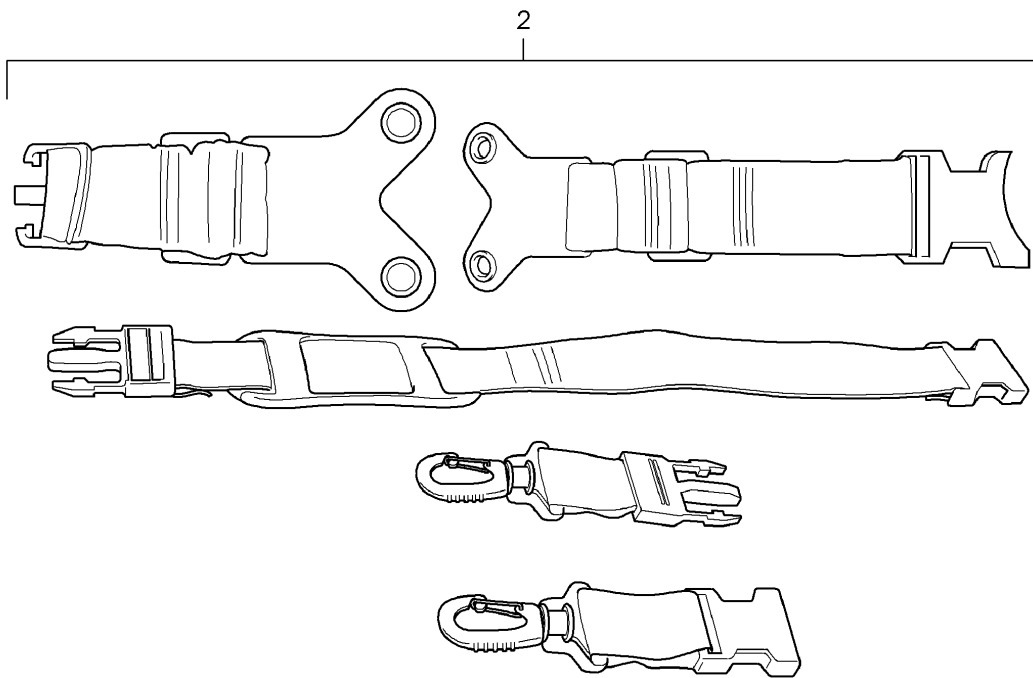
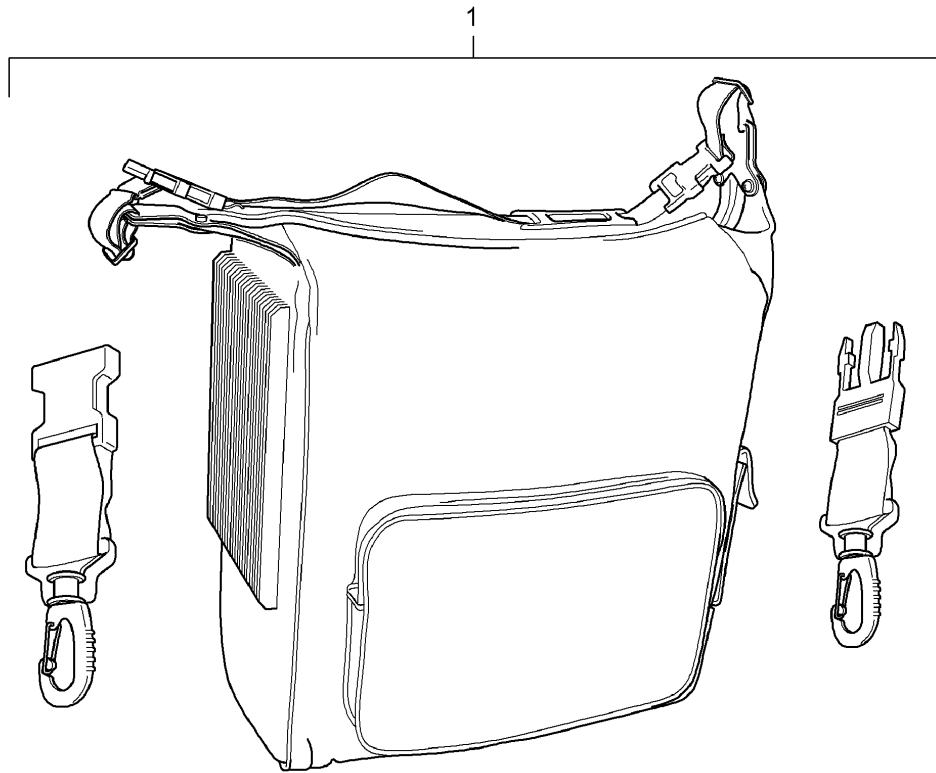

Model: TEQ 3

Model life 2010>>

Pos	Part Number	Description	Remark	Qty	Model
-		Cooling bag D - MJ 2010>> Technical information Panamera Group 6 6832 (16/09) Attention			alle
1	955 044 902 30	Cooling bag Electric		1	
2	955 044 900 23	repair set Fastening clip Belt for Cooling bag 955.044.902.30		1	

Model: TEQ 3

Model life 2010>>

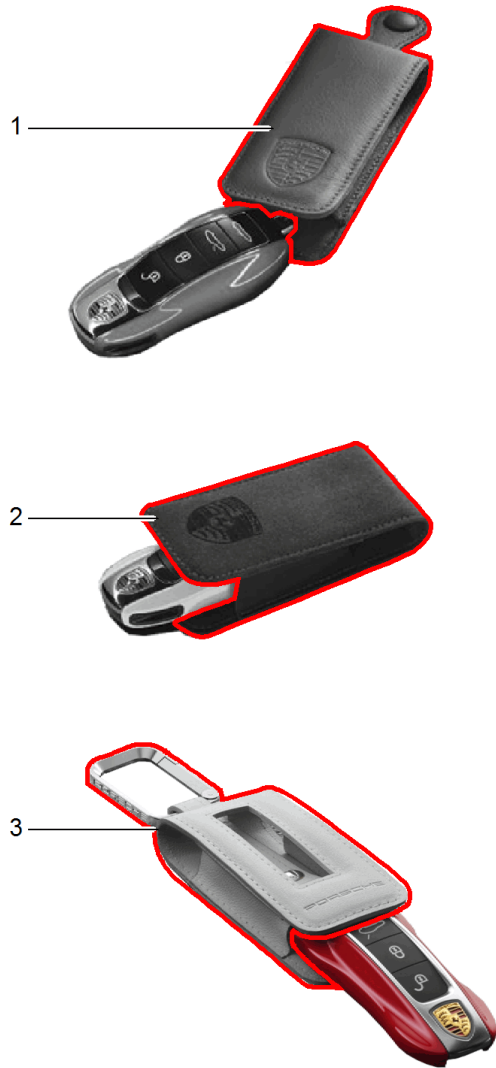

Model: TEQ 3 Model life 2010>>

Pos	Part Number	Description	Remark	Qty	Model
1	970 044 001 00	Key case Leather and Alcantara D - MJ 2010>>		1	
(1)	970 044 001 01	Key case Leather Platinum Grey D - MJ 2010>> - MJ 2016		1	
(1)	970 044 001 02	Key case Leather Black D - MJ 2010>> - MJ 2016		1	
(1)	970 044 001 03	Key case Leather Luxor beige D - MJ 2010>> - MJ 2016		1	
(1)	970 044 001 04	Key case Leather Espresso D - MJ 2010>> - MJ 2016		1	
(1)	970 044 001 05	Key case Leather yachting blue D - MJ 2010>> - MJ 2016		1	
(1)	970 044 001 06	Key case Leather Cognac D - MJ 2010>> - MJ 2016		1	
(1)	970 044 001 07	Key case Leather Umber D - MJ 2010>> - MJ 2016		1	
(1)	970 044 001 08	Key case Leather Marsala Red D - MJ 2010>> - MJ 2016		1	
(1)	970 044 001 09	Key case Leather agate grey D - MJ 2010>> - MJ 2016		1	
(1)	970 044 001 10	Key case Leather Leather colour/garnet red/ Carrera red D - MJ 2010>> - MJ 2016		1	
(1)	970 044 001 11	Key case Leather saddle brown D - MJ 2010>> - MJ 2016		1	
(1)	970 044 001 12	Key case Leather Bordeaux red D - MJ 2010>> - MJ 2016		1	
(1)	970 044 001 13	Key case Leather Graphite Blue D - MJ 2010>> - MJ 2016		1	
2	000 044 001 10	Key case Leather mojave beige Alcantara		1	

Model: TEQ 3

Model life 2010>>

Pos	Part Number	Description	Remark	Qty	Model
3		Black		1	
			with:		
			Decorative stitching		
			in		
			D - MJ 2010>> - MJ 2016		
		000 044 001 10 7T2	Black		
		000 044 001 10 8E9	Platinum Grey		
		000 044 001 10 M2A	Lava Orange		
		000 044 001 10 N13	guards red (Porsche)		
		971 044 003	Key case		
			Leather paint		
			D - MJ 2017>>		
		971 044 003 6G0	Cream		
		971 044 003 8M8	Marsala Red		
		971 044 003 8YR	Black		
		971 044 003 9H6	Luxor beige		
		971 044 003 OG6	Bordeaux red		
	971 044 003 OH7	Graphite Blue			
	971 044 003 OK6	saddle brown			
	971 044 003 OL8	Chalk			
	971 044 003 ON1	Cohiba Brown			
	971 044 003 OT2	Truffle Brown			
	971 044 003 OT5	beige			
		Mojave			
	971 044 003 OU6	Slate grey			
	971 044 003 PL1	agate grey			

Model: TEQ 3

Model life 2010>>



Model: TEQ 3 Model life 2010>>

Pos	Part Number	Description	Remark	Qty	Model
1	970 044 000 25	Sun visor Rear window D - MJ 2010>> - MJ 2013 Sun visor Rear window		1	PR:426
(1)	970 044 000 26	Rear window wiper Sun visor Rear window Rear window wiper	without: with:	1	PR:425

Model: TEQ 3

Model life 2010>>



Model: TEQ 3 Model life 2010>>

Pos	Part Number	Description	Remark	Qty	Model
		Polish			
		D - MJ 2010>>			
1	999 901 065 40	Insect remover	500 ml	1	
2	000 044 000 87	Window cleaning solution	250 ml	1	
		Windscreen washer system			
-	000 044 002 07	Winter window cleaner	1000 ml	1	
		Windscreen washer system			
-	000 044 002 27	Winter window cleaner	1000 ML	1	
		Windscreen washer system			
3	999 901 016 41	Window cleaning solution	100 ml	1	
(3)	000 044 000 74	Window cleaning solution	100 ml inner	1	
4	000 044 000 92	Paint polish		1	
5	000 044 000 90	Polish	250 ml	1	
		Paint			
		Wax			
		Discontinued part			
(5)	999 901 069 40	Polish	250 ml	1	
		Paint			
		Wax			
6	999 901 062 40	Car shampoo	250 ml	1	
7	000 044 000 03	Leather care product	100 ml	1	
8	999 901 068 40	Leather care product	100 ml	1	
		Cleaning solution			
9	999 901 066 41	Rim cleaner	500 ml	1	
		Spray bottle			
		Discontinued part			
10	999 901 066 40	Rim cleaner	1000 ml	1	
		Refilling bottle			
		Discontinued part			
11	000 044 001 89	Care kit		1	
		Pocket			
12	000 044 001 87	Care kit		1	
		Rim cleaner			
		Pocket			
13	000 044 000 95	Cleaning solution		1	
		Cloth			
		Set			
14	955 044 000 02	ice scraper		1	
-	999 901 021 40	Polishing wadding		1	
-	999 901 022 40	Polishing cloth		1	
15	000 044 001 00	Care kit		1	
		Leather care product			
16	000 044 000 96	Sponge		1	
		inscription			
		Porsche			
17	000 044 001 03	Care kit		1	
		Winter			

Model: TEQ 3

Model life 2010>>



Model: TEQ 3 Model life 2010>>

Pos	Part Number	Description	Remark	Qty	Model
1	000 044 001 02	Polish White Care kit		1	
2	000 044 002 20	Polish White Car polish		1	
3	000 044 002 18	Paint Polish White		1	
4	000 044 002 13	'Hard wax' car polish Leather care product White		1	
5	000 044 002 10	Polishing agent for leather Leather care product White		1	
6	000 044 002 23	Leather cleaner Insect remover White		1	
7	000 044 002 24	Insect remover Window cleaning solution White	inner	1	
8	000 044 002 11	Car shampoo White Paint and		1	
9	000 044 002 15	Cabrio roof Rim cleaner White		1	
10	000 044 000 96	Aerosol can Sponge With lettering:	PORSCHE	1	

Model: TEQ 3

Model life 2010>>

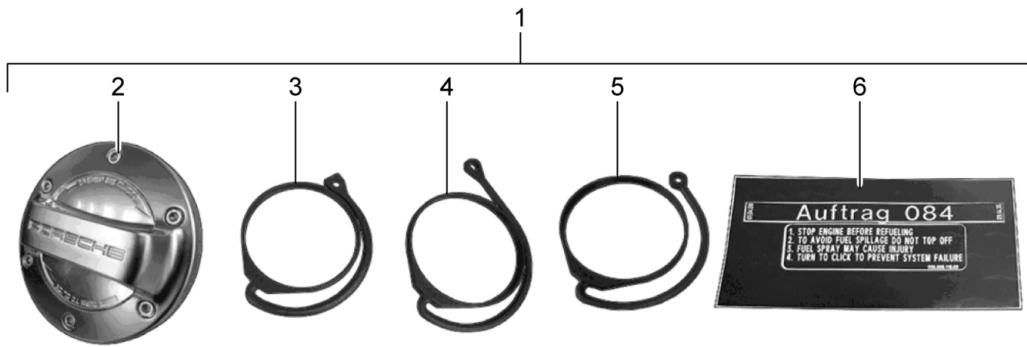
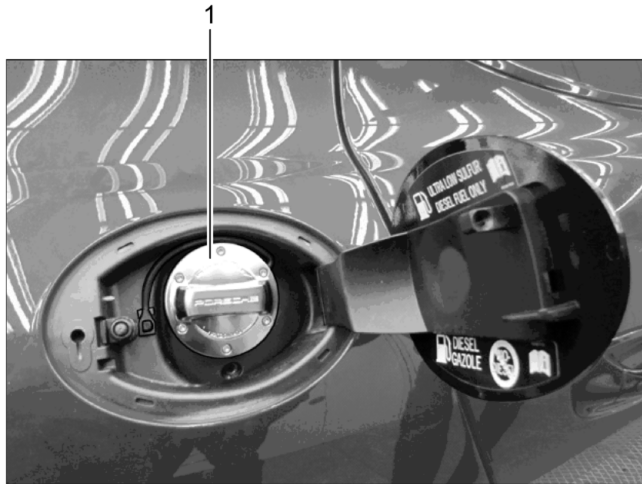

Model: TEQ 3 Model life 2010>>

Pos	Part Number	Description	Remark	Qty	Model
-		Fuel tank cap Aluminium look D - MJ 2010>> - MJ 2016 Inst. & Conv. Instructions Panamera Group 2 2005 (53/12) Attention			alle
1	000 044 001 91	cap with retaining strap for fuel tank Aluminium look Set		1	
2		Fuel tank cap Aluminium look D >> - MJ 2016		1	
3		Holding strap		1	Panamera
4		Holding strap		1	Cayenne
5		Holding strap		1	Sportwagen
(6)	996 006 118 01	Sticker Warning note		1	00004400190
6	7P5 010 869 D	Sticker Warning note		1	00004400191

Model: TEQ 3

Model life 2010>>



Model: TEQ 3 Model life 2010>>

Pos	Part Number	Description	Remark	Qty	Model
-		Sports tailpipe D - MJ 2011>> - MJ 2016 use if required:			
-	970 111 360 00	nut, square M8		2	
-	970 111 547 00	Locknut M6		4	Turbo / Turbo S
-	955 111 220 12	Clamping sleeve 60 X 95		2	S / 4S
-	955 111 220 21	Clamping sleeve 65 X 95		2	Turbo / Turbo S
-		Inst. & Conv. Instructions Panamera Group 2 2634 (49/10) Attention	11-13		OHNE/NOT FOR Diesel Hybrid GTS
1	970 044 200 00	Tailpipe Sports tailpipe Set	11-13	1	Panamera / 4 S / 4S PR:-176,-XLF
(1)	970 044 200 01	Tailpipe Sports tailpipe Set	11-13	1	Turbo / S PR:-176
-		Inst. & Conv. Instructions Panamera 2nd GENERATION Group 2 2634 (5/14) Attention	14-16		
(1)	970 044 200 22	Tailpipe Sports tailpipe Double silver Set	14-16	1	S/4S/Turbo Turbo S E-Hybrid Executive PR:-176,0E1, 0E2
(1)	970 044 200 26	Tailpipe Sports tailpipe Double Black Set	14-16	1	S/4S/Turbo Turbo S E-Hybrid Executive PR:-176,0E1, 0E2
(1)	970 044 200 27	Exhaust tail pipe Double Black Set	14-16	1	Panamera / 4 S/4S/Turbo Turbo S Executive Panamera GTS PR:176,XLF, 0E1,0E2 -"CN."
-		Inst. & Conv. Instructions Panamera 2nd GENERATION Group 2 2634 (18/14) Attention	14-16		
(1)	970 044 200 21	Tailpipe Sports tailpipe Simple silver Set	14-16	1	Panamera / 4 Diesel Executive PR:-XLF,0E1, 0E2
(1)	970 044 200 25	Tailpipe Sports tailpipe Simple Black	14-16	1	Panamera / 4 Diesel Executive PR:-XLF,0E1,

Model: TEQ 3

Model life 2010>>

Pos	Part Number	Description	Remark	Qty	Model
		Set			0E2

Model: TEQ 3

Model life 2010>>

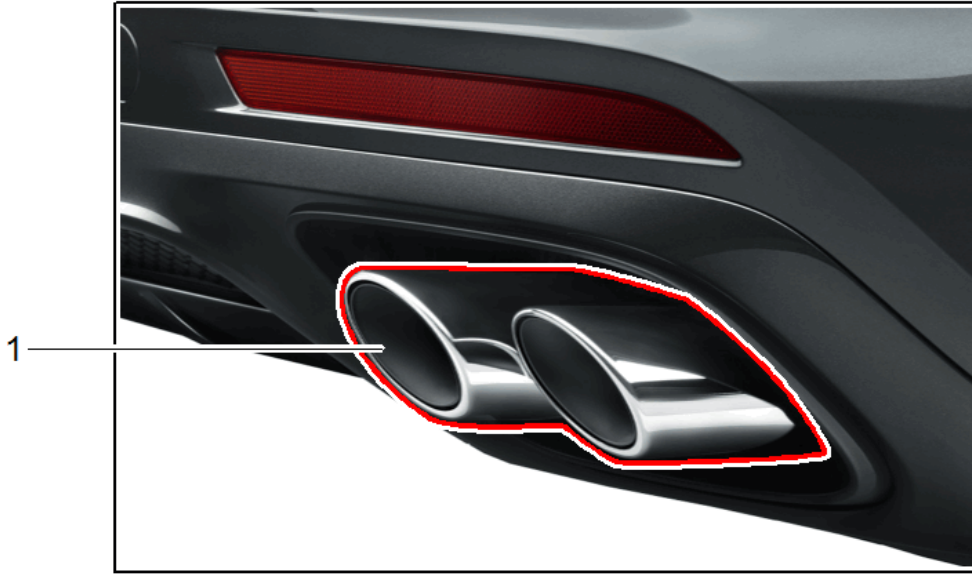

Model: TEQ 3 Model life 2010>>

Pos	Part Number	Description	Remark	Qty	Model
-		Sports tailpipe D - MJ 2017>> Inst. & Conv. Instructions Panamera Group 2 2635 (03/17) Attention			
1	971 044 200	Tailpipe Sport Simple Brushed stainless steel Set Included Fasteners		1	Panamera 4S 4S Diesel Turbo Turbo S PHEV SportTurismo 4S ST 4S Diesel ST Turbo ST PR:0E1,0E2
(1)	971 044 200 A	D - MJ 2017>> Tailpipe Sport chromed silver Set Included Fasteners		1	Panamera 4S 4S Diesel Turbo Turbo S PHEV SportTurismo 4S ST 4S Diesel ST Turbo ST PR:0E1,0E2
2	971 044 200 B	D - MJ 2017>> Tailpipe Sport chromed Black Set Included Fasteners		1	Panamera 4S 4S Diesel Turbo Turbo S PHEV SportTurismo 4S ST 4S Diesel ST Turbo ST PR:0E1,0E2
-		D - MJ 2017>> Inst. & Conv. Instructions Panamera Group 2 2635 (15/17) Attention			
(1)	971 044 205 A	Tailpipe Sport Simple chromed silver Set		1	Panamera Panamera 4 SportTurismo 4 ST PR:0E1,0E2
(1)	971 044 206 A	Rear silencer D - MJ 2017>> Tailpipe Sport Simple chromed silver Set	with:	1	Panamera 4 PHEV SportTurismo 4 PHEV ST PR:0E1,0E2, OK3
		Rear silencer D - MJ 2017>>	with:		

Model: TEQ 3 Model life 2010>>

Pos	Part Number	Description	Remark	Qty	Model
(2)	971 044 205 B	Tailpipe Sport Simple chromed Black Set Rear silencer D - MJ 2017>>	with:	1	Panamera Panamera 4 SportTurismo 4 ST PR:0E1,0E2
(2)	971 044 206 B	Tailpipe Sport Simple chromed Black Set Rear silencer D - MJ 2017>>	with:	1	Panamera 4 PHEV SportTurismo 4 PHEV ST PR:0E1,0E2, 0K3

Model: TEQ 3

Model life 2010>>

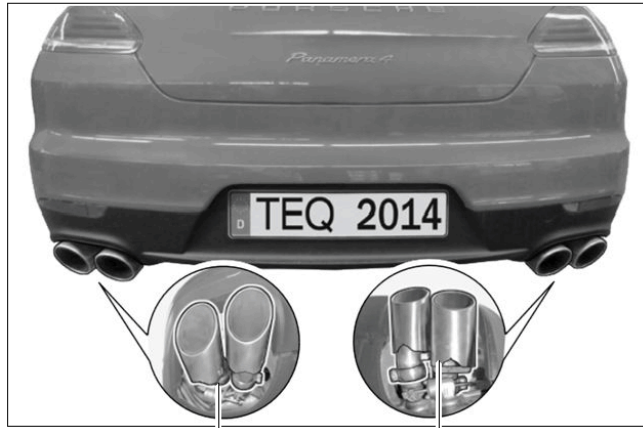
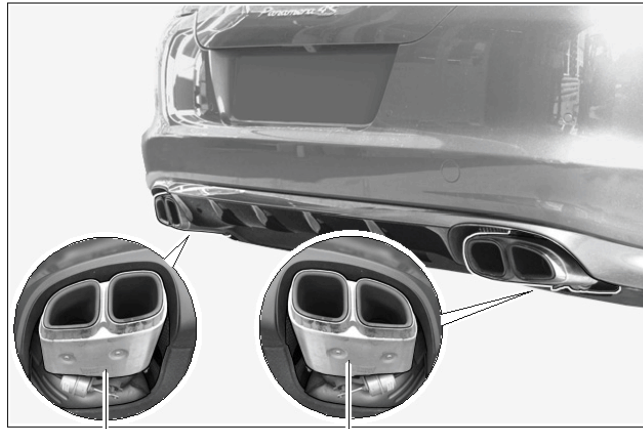

Model: TEQ 3 Model life 2010>>

Pos	Part Number	Description	Remark	Qty	Model
-		exhaust system Sport version note: Inst. & Conv. Instructions 2601 (37/10)	10-16 17-		S/4S/Turbo
1	970 044 200 10	exhaust system Sport version D >> - MJ 2013		1	S / 4S PR:-176
2	970 044 200 29	exhaust system Sport version D - MJ 2014>>		1	S / 4S PR:-176
(1)	970 044 200 15	exhaust system Sport version D >> - MJ 2013		1	Turbo PR:-176
(2)	970 044 200 32	exhaust system Sport version Body Short		1	Turbo PR:-176
(2)	970 044 200 33	also use: D - MJ 2014>> exhaust system Sport version Body Long	970 355 578 04	1	Turbo PR:-176
-		also use: D - MJ 2014>> Inst. & Conv. Instructions Panamera Group 2 2601 (12/11)	970 355 578 04		V6
(1)	970 044 200 05	exhaust system Sport version D - MJ 2011>> - MJ 2013		1	Panamera Panamera 4 PR:-XLF -"CN."
(2)	970 044 200 30	exhaust system Sport version D - MJ 2014>>		1	Panamera Panamera 4 PR:-XLF -"CN."
3	971 044 201 A	exhaust system Sport version Included Trim Tailpipe silver		1	PR:T9I,0E1, 0E2
(3)	971 044 201 B	D - MJ 2017>> exhaust system Sport version Included Trim Tailpipe Black		1	PR:T9I,0E1, 0E2
(3)	971 044 203 A	D - MJ 2017>> exhaust system Sport version Included Trim Tailpipe silver		1	PHEV PR:TV8,0K3, 0E1
(3)	971 044 203 B	D - MJ 2017>> exhaust system Sport version Included Trim		1	PHEV PR:TV8,0K3, 0E1

Model: TEQ 3 Model life 2010>>

Pos	Part Number	Description	Remark	Qty	Model
(3)	971 044 204 A	Tailpipe Black D - MJ 2017>> exhaust system Sport version Included Trim Tailpipe silver		1	PHEV PR:TV8,0K3, 0E2
(3)	971 044 204 B	D - MJ 2017>> exhaust system Sport version Included Trim Tailpipe Black		1	PHEV PR:TV8,0K3, 0E2
(3)	971 044 221	D - MJ 2017>> exhaust system Sport version without: Trim Tailpipe		1	Panamera 4S PR:TV8,0E1
(3)	971 044 222	D - MJ 2017>> exhaust system Sport version without: Trim Tailpipe		1	4S Diesel PR:TI4,0E1
(3)	971 044 223	When ordering, note/check the vehicle identification number. WP0ZZZ97ZHL132363 from production no.: exhaust system Sport version without: Trim Tailpipe		1	Turbo PR:T1M,0E1
(3)	971 044 224	D - MJ 2017>> exhaust system Sport version without: Trim Tailpipe		1	Turbo PR:T1M,0E2
(3)	971 044 225	D - MJ 2017>> exhaust system Sport version without: Trim Tailpipe		1	Turbo S PHEV PR:T1M,0K3, 0E1
(3)	971 044 226	D - MJ 2017>> exhaust system Sport version without: Trim Tailpipe		1	Turbo S PHEV PR:T1M,0K3, 0E2
		D - MJ 2017>>			

Model: TEQ 3

Model life 2010>>

1

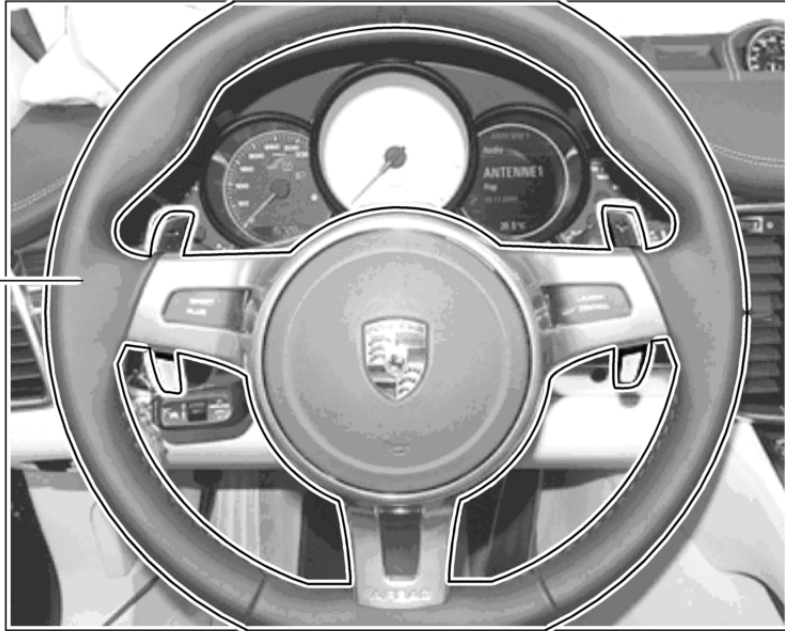

Model: TEQ 3 Model life 2010>>

Pos	Part Number	Description	Remark	Qty	Model
-		sports steering wheel Shifting paddle D - MJ 2010>> Inst. & Conv. Instructions Panamera Group 4 4810 (44/09) Attention			alle
1	970 044 400 00	sports steering wheel with: Shifting paddle only in conj. with: Tiptronic - PDK - 970 044 400 00 A34 Black 970 044 400 00 6H6 Espresso 970 044 400 00 7M9 yachting blue 970 044 400 00 8T3 Platinum Grey 970 044 400 00 9J9 Luxor beige 970 044 400 00 OE5 agate grey 970 044 400 00 OK6 saddle brown		1	PR:249,250
(1)	970 044 400 01	sports steering wheel with: Shifting paddle only in conj. with: - PDK - 970 044 400 01 A34 Black 970 044 400 01 6H6 Espresso 970 044 400 01 7M9 yachting blue 970 044 400 01 8T3 Platinum Grey 970 044 400 01 9J9 Luxor beige 970 044 400 01 OE5 agate grey 970 044 400 01 OK6 saddle brown		1	PR:639,640, 250
-		also use: Steering column switch see illustration: Panamera	903-010	1	

Model: TEQ 3

Model life 2010>>

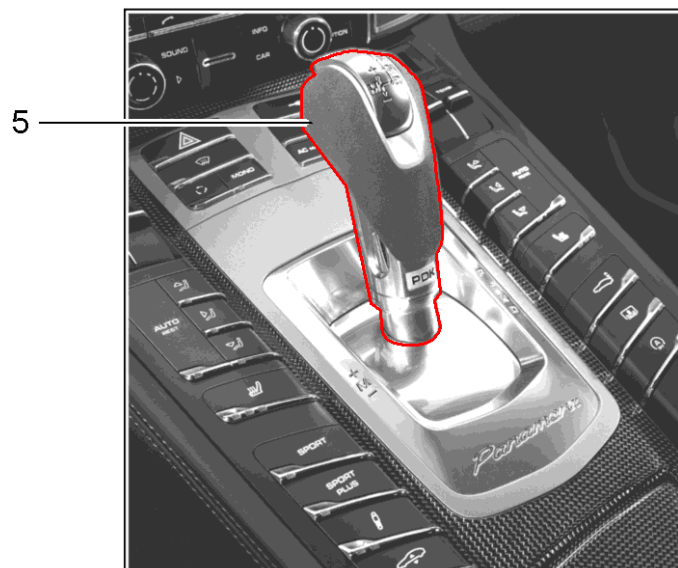
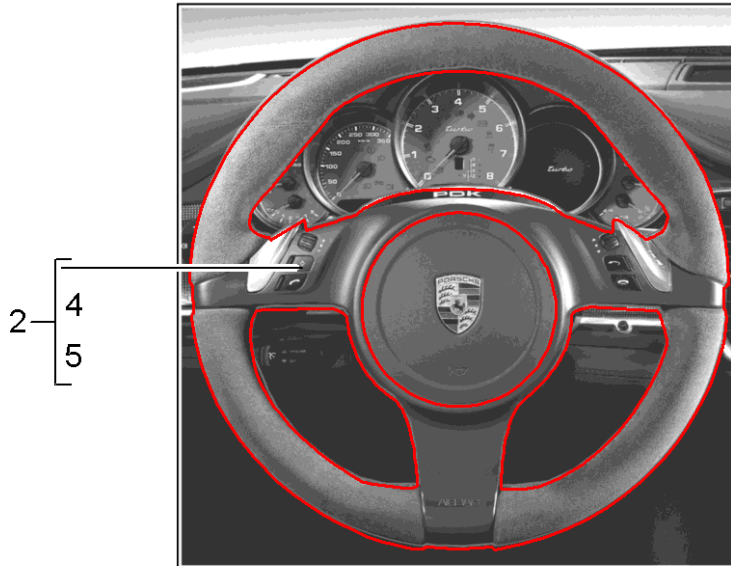
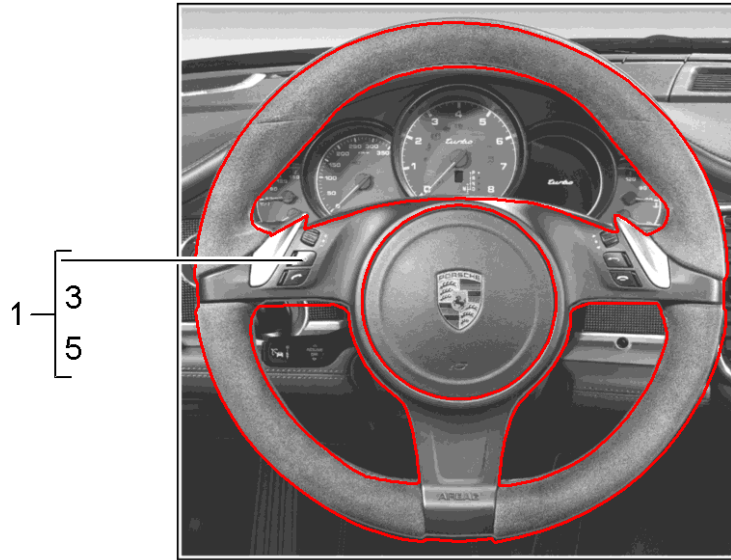

Model: TEQ 3 Model life 2010>>

Pos	Part Number	Description	Remark	Qty	Model
-		steering wheel Multi-function selector lever Alcantara D - MJ 2010>> only in conj. with:			
1	970 044 801 80	Multi-function multifunction steering wheel		1	PR:-639, -640,250
2	970 044 801 81	selector lever - PDK - Set multifunction steering wheel		1	PR:639,640, 250
3	970 044 400 02	selector lever - PDK - Set multifunction steering wheel Alcantara only in conj. with:		1	PR:249,250
4	970 044 400 03	Tiptronic - PDK - multifunction steering wheel		1	PR:639,640, 250
5	970 426 990 01	Alcantara only in conj. with: - PDK - selector lever Alcantara only in conj. with: - PDK -		1	PR:250

Model: TEQ 3

Model life 2010>>



1



2

Model: TEQ 3

Model life 2010>>

Pos	Part Number	Description	Remark	Qty	Model
-		multifunction steering wheel Light Paldao Carbon	17-		
-		only in conj. with: multifunction steering wheel			
-		For vehicles with steering wheel heating (Installed as standard) or Pushbutton for steering wheel heating (no function)			
1	971 044 400	mult.steering wheel (leather) - PDK - Light Paldao		1	PR:QR0,QR3, OK0,250
	971 044 400 A34	Light paldao/black			
	971 044 400 OE5	Light paldao/agate grey			
	971 044 400 9J9	Light paldao/luxor beige			
	971 044 400 OK6	Light paldao/saddle brown			
	971 044 400 8U7	Light paldao/marsala red			
	971 044 400 OT2	Truffle Brown			
	971 044 400 ON1	Cohiba Brown			
(1)	971 044 401	mult.steering wheel (leather) - PDK - Light Paldao		1	PR:QR5,OK0, 250
	971 044 401 A34	Light paldao/black			
	971 044 401 OE5	Light paldao/agate grey			
	971 044 401 9J9	Light paldao/luxor beige			
	971 044 401 OK6	Light paldao/saddle brown			
	971 044 401 8U7	Light paldao/marsala red			
	971 044 401 OT2	Truffle Brown			
	971 044 401 ON1	Cohiba Brown			
(1)	971 044 402	mult.steering wheel (leather) - PDK - Light Paldao		1	PR:QR5,OK3, 250
	971 044 402 A34	Light paldao/black			
	971 044 402 OE5	Light paldao/agate grey			
	971 044 402 9J9	Light paldao/luxor beige			
	971 044 402 OK6	Light paldao/saddle brown			
	971 044 402 8U7	Light paldao/marsala red			
	971 044 402 OT2	Truffle Brown			
	971 044 402 ON1	Cohiba Brown			
2	971 044 403	multifunction steering wheel - PDK - Carbon		1	PR:QR0,QR3, OK0,250
	971 044 403 A34	Black			
	971 044 403 OE5	agate grey			
	971 044 403 9J9	Luxor beige			
	971 044 403 OK6	saddle brown			
	971 044 403 8U7	Marsala Red			
	971 044 403 OT2	Truffle Brown			
	971 044 403 ON1	Cohiba Brown			
(2)	971 044 404	multifunction steering wheel - PDK - Carbon		1	PR:QR5,OK0, 250
	971 044 404 A34	Black			
	971 044 404 OE5	agate grey			
	971 044 404 9J9	Luxor beige			
	971 044 404 OK6	saddle brown			
	971 044 404 8U7	Marsala Red			
	971 044 404 OT2	Truffle Brown			
	971 044 404 ON1	Cohiba Brown			
(2)	971 044 405	multifunction steering wheel		1	PR:QR5,OK3,

Model: TEQ 3 Model life 2010>>

Pos	Part Number	Description	Remark	Qty	Model
		- PDK - Carbon			250
	971 044 405 A34	Black			
	971 044 405 OE5	agate grey			
	971 044 405 9J9	Luxor beige			
	971 044 405 OK6	saddle brown			
	971 044 405 8U7	Marsala Red			
	971 044 405 OT2	Truffle Brown			
	971 044 405 ON1	Cohiba Brown			

Model: TEQ 3

Model life 2010>>

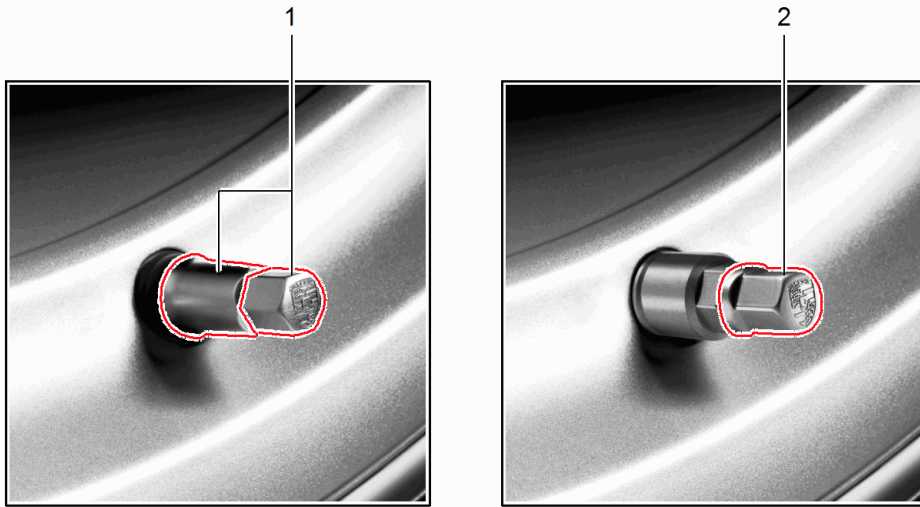

Model: TEQ 3 Model life 2010>>

Pos	Part Number	Description	Remark	Qty	Model
1	000 044 601 00	Valve cap Porsche crest silver Black D - MJ 2010>> Cap Valve cap		1	PR:-482,-483
		with: Porsche crest Set Included Rubber valve Cap Valve cap			
2	000 044 602 15	Cap Valve cap		1	PR:482,483
		with: Porsche crest Set Discontinued part Cap Valve cap			
3	991 044 602 66	Black Porsche crest Coloured Set Cap Valve cap		1	PR:-482,-483
(3)	991 044 602 67	Black Porsche crest Coloured Set Cap Valve cap		1	PR:482,483
4	991 044 602 69	Black Porsche crest Coloured Set Cap Valve cap silver		1	PR:482,483
5	991 044 602 65	Porsche crest Coloured Set Cap Valve cap Black		1	PR:-482,-483
6	991 044 602 68	Porsche crest Black-white Set Cap Valve cap silver		1	PR:482,483
		Porsche crest Black-white Set			

Model: TEQ 3

Model life 2010>>



1



2



3



4



5



6



7



8



9



10



11



12

Model: TEQ 3 Model life 2010>>

Pos	Part Number	Description	Remark	Qty	Model
-		Gear wheel sets Summer D - MJ 2010>> - MJ 2016 Information Manufacturer Approval Wheels and tyres in Piwis Group 4 suspension Attention Attention PCCB only in conj. with: 20-ZOLL GTS, TURBO, TURBO S only in conj. with: 19/20-ZOLL PANAMERA, S, 4, 4S, DIESEL, S HYBRID			Panamera G1
1	970 044 602 83	Set of wheels, compl. 19-ZOLL PANAMERA DESIGN 9J X 19'' ET60 255/45 ZR19 (100Y) 10J X 19'' ET61 285/40 ZR19 (103Y) silver MICHELIN also use: use if required:	970 044 600 14 970 044 500 00	1	PR:-482 2x5mm
(1)	970 044 602 84	D - MJ 2010>> - MJ 2013 Set of wheels, compl. 19-ZOLL PANAMERA DESIGN 9J X 19'' ET60 255/45 ZR19 (100Y) 10J X 19'' ET61 285/40 ZR19 (103Y) silver MICHELIN also use: use if required:	970 044 600 14 970 044 500 00	1	PR:482 2x5mm
2	970 044 602 35	D - MJ 2010>> - MJ 2013 Set of wheels, compl. 19-ZOLL PANAMERA DESIGN II 9J X 19'' ET60 255/45 ZR19 (100Y) 10J X 19'' ET61 285/40 ZR19 (103Y) silver MICHELIN also use: use if required:	2010-13 2014-16 970 044 600 14 970 044 500 00	1	PR:-482,-092 2x5mm
(2)	970 044 602 36	Set of wheels, compl. 19-ZOLL PANAMERA DESIGN II 9J X 19'' ET60 255/45 ZR19 (100Y) 10J X 19'' ET61 285/40 ZR19 (103Y) silver MICHELIN also use: use if required:	970 044 600 14 970 044 500 00	1	PR:482 2x5mm
		D - MJ 2010>> - MJ 2013	970 044 600 14 970 044 500 00		2x5mm

Model: TEQ 3 Model life 2010>>

Pos	Part Number	Description	Remark	Qty	Model
(2)	970 044 602 38	Set of wheels, compl. 19-ZOLL PANAMERA DESIGN II 9J X 19'' ET60 255/45 ZR19 (100Y) 10J X 19'' ET61 285/40 ZR19 (103Y) silver MICHELIN		1	PR:482,-092
			also use: 970 044 600 14 use if required: 970 044 500 00		2x5mm
3	970 044 602 31	D - MJ 2014>> - MJ 2016 Set of wheels, compl. 19-ZOLL PANAMERA TURBO II 9J X 19'' ET60 255/45 ZR19 (100Y) 10J X 19'' ET61 285/40 ZR19 (103Y) silver MICHELIN	2010-13 2014-16	1	PR:-482,-092
			also use: 970 044 600 14 use if required: 970 044 500 00		2x5mm
(3)	970 044 600 65	Set of wheels, compl. 19-ZOLL PANAMERA TURBO II 9J X 19'' ET60 255/45 R19 100V M+S 10J X 19'' ET61 285/40 R19 103V M+S silver MICHELIN ALL SEASON Not Together with Shim	2010-13 2014-16	1	PR:-482,-092
			also use: 970 044 600 14 use if required: 970 044 600 10		
(3)	970 044 602 32	Set of wheels, compl. 19-ZOLL PANAMERA TURBO II 9J X 19'' ET60 255/45 ZR19 (100Y) 10J X 19'' ET61 285/40 ZR19 (103Y) silver MICHELIN		1	PR:482
			also use: 970 044 600 14 use if required: 970 044 500 00		2x5mm
(3)	970 044 602 34	D - MJ 2010>> - MJ 2013 Set of wheels, compl. 19-ZOLL PANAMERA TURBO II 9J X 19'' ET60 255/45 ZR19 (100Y) 10J X 19'' ET61 285/40 ZR19 (103Y) silver MICHELIN		1	PR:482,-092
			also use: 970 044 600 14 use if required: 970 044 500 00		2x5mm
(3)	970 044 600 66	D - MJ 2014>> - MJ 2016 Set of wheels, compl. 19-ZOLL PANAMERA TURBO II 9J X 19'' ET60 255/45 R19 100V M+S 10J X 19'' ET61 285/40 R19 103V M+S silver		1	PR:482

Model: TEQ 3 Model life 2010>>

Pos	Part Number	Description	Remark	Qty	Model
(3)	970 044 600 68	MICHELIN ALL SEASON Not Together with Shim also use: use if required: D - MJ 2010>> - MJ 2013 Set of wheels, compl. 19-ZOLL PANAMERA TURBO II 9J X 19'' ET60 255/45 R19 100V M+S 10J X 19'' ET61 285/40 R19 103V M+S silver MICHELIN ALL SEASON Not Together with Shim also use: use if required:	970 044 600 14 970 044 600 10	1	PR:482,-092
4	970 044 602 39	D - MJ 2014>> - MJ 2016 Set of wheels, compl. 19-ZOLL PANAMERA CLASSIC 9J X 19'' ET60 255/45 ZR19 (100Y) 10J X 19'' ET61 285/40 ZR19 (103Y) two-colour MICHELIN also use: use if required:	970 044 600 14 970 044 600 10 2010-13 2014-16	1	PR:-482,-092
(4)	970 044 602 40	Set of wheels, compl. 19-ZOLL PANAMERA CLASSIC 9J X 19'' ET60 255/45 ZR19 (100Y) 10J X 19'' ET61 285/40 ZR19 (103Y) two-colour MICHELIN also use: use if required:	970 044 600 14 970 044 500 00	1	2x5mm PR:482
(4)	970 044 602 42	D - MJ 2010>> - MJ 2013 Set of wheels, compl. 19-ZOLL PANAMERA CLASSIC 9J X 19'' ET60 255/45 ZR19 (100Y) 10J X 19'' ET61 285/40 ZR19 (103Y) two-colour MICHELIN also use: use if required:	970 044 600 14 970 044 500 00	1	2x5mm PR:482,-092
5	970 044 602 43	D - MJ 2014>> - MJ 2016 Set of wheels, compl. 20-ZOLL RS SPYDER DESIGN 9,5J X 20'' ET65 255/40 ZR20 (101Y) XL 11J X 20'' ET68 295/35 ZR20 (105Y) XL silver MICHELIN also use: use if required:	970 044 600 14 970 044 500 00	1	PR:-482 2x5mm

Model: TEQ 3 Model life 2010>>

Pos	Part Number	Description	Remark	Qty	Model
(5)	970 044 602 44	D - MJ 2010>> - MJ 2016 Set of wheels, compl. 20-ZOLL RS SPYDER DESIGN 9,5J X 20'' ET65 255/40 ZR20 (101Y) XL 11J X 20'' ET68 295/35 ZR20 (105Y) XL silver MICHELIN		1	PR:482
			also use: 970 044 600 14 use if required: 970 044 500 00		2x5mm
(5)	970 044 602 46	D - MJ 2010>> - MJ 2013 Set of wheels, compl. 20-ZOLL RS SPYDER DESIGN 9,5J X 20'' ET65 255/40 ZR20 (101Y) XL 11J X 20'' ET68 295/35 ZR20 (105Y) XL silver MICHELIN		1	PR:482
			also use: 970 044 600 14 use if required: 970 044 500 00		2x5mm
6	970 044 602 47	D - MJ 2014>> - MJ 2016 Set of wheels, compl. 20-ZOLL 911 TURBO II 9,5J X 20'' ET65 255/40 ZR20 (101Y) XL 11J X 20'' ET68 295/35 ZR20 (105Y) XL two-colour MICHELIN		1	PR:-482
			also use: 970 044 600 12 use if required: 970 044 500 00		2x5mm
(6)	970 044 602 48	D - MJ 2010>> - MJ 2016 Set of wheels, compl. 20-ZOLL 911 TURBO II 9,5J X 20'' ET65 255/40 ZR20 (101Y) XL 11J X 20'' ET68 295/35 ZR20 (105Y) XL two-colour MICHELIN		1	PR:482
			also use: 970 044 600 12 use if required: 970 044 500 00		2x5mm
(6)	970 044 602 50	D - MJ 2010>> - MJ 2013 Set of wheels, compl. 20-ZOLL 911 TURBO II 9,5J X 20'' ET65 255/40 ZR20 (101Y) XL 11J X 20'' ET68 295/35 ZR20 (105Y) XL two-colour MICHELIN		1	PR:482
			also use: 970 044 600 12 use if required: 970 044 500 00		2x5mm
7	970 044 602 51	D - MJ 2014>> - MJ 2016 Set of wheels, compl. 20'' 911 TURBO III DESIGN 9,5J X 20'' ET65 255/40 ZR20 (101Y) XL 11J X 20'' ET68 295/35 ZR20 (105Y) XL two-colour		1	PR:-482

Model: TEQ 3 Model life 2010>>

Pos	Part Number	Description	Remark	Qty	Model
(7)	970 044 602 52	MICHELIN also use: use if required: D - MJ 2010>> - MJ 2016 Set of wheels, compl. 20'' 911 TURBO III DESIGN 9,5J X 20'' ET65 255/40 ZR20 (101Y) XL 11J X 20'' ET68 295/35 ZR20 (105Y) XL two-colour MICHELIN	970 044 600 23 970 044 500 00	1	2x5mm PR:482
(7)	970 044 602 54	MICHELIN also use: use if required: D - MJ 2010>> - MJ 2013 Set of wheels, compl. 20'' 911 TURBO III DESIGN 9,5J X 20'' ET65 255/40 ZR20 (101Y) XL 11J X 20'' ET68 295/35 ZR20 (105Y) XL two-colour MICHELIN	970 044 600 23 970 044 500 00	1	2x5mm PR:482
8	970 044 602 55	MICHELIN also use: use if required: D - MJ 2014>> - MJ 2016 Set of wheels, compl. 20-ZOLL PANAMERA SPORT 9,5J X 20'' ET65 255/40 ZR20 (101Y) XL 11,5J X 20'' ET63 295/35 ZR20 (105Y) XL GT Silver Metallic MICHELIN Not Together with Shim	970 044 600 23 970 044 500 00	1	2x5mm PR:-482
(8)	970 044 600 59	MICHELIN also use: D - MJ 2010>> - MJ 2016 Set of wheels, compl. 20-ZOLL PANAMERA SPORT 9,5J X 20'' ET65 255/40 R20 101V XL M+S 11,5J X 20'' ET63 295/35 R20 105V XL M+S GT Silver Metallic MICHELIN ALL SEASON Not Together with Shim	970 044 600 13	1	PR:-482
(8)	970 044 602 56	MICHELIN also use: D - MJ 2010>> - MJ 2016 Set of wheels, compl. 20-ZOLL PANAMERA SPORT 9,5J X 20'' ET65 255/40 ZR20 (101Y) XL 11,5J X 20'' ET63 295/35 ZR20 (105Y) XL GT Silver Metallic MICHELIN Not Together with Shim	970 044 600 13	1	PR:482

Model: TEQ 3 Model life 2010>>

Pos	Part Number	Description	Remark	Qty	Model
(8)	970 044 602 58	<p style="text-align: right;">also use:</p> D - MJ 2010>> - MJ 2013 Set of wheels, compl. 20-ZOLL PANAMERA SPORT 9,5J X 20'' ET65 255/40 ZR20 (101Y) XL 11,5J X 20'' ET63 295/35 ZR20 (105Y) XL GT Silver Metallic MICHELIN Not Together with Shim	970 044 600 13	1	PR:482
(8)	970 044 600 60	<p style="text-align: right;">also use:</p> D - MJ 2014>> - MJ 2016 Set of wheels, compl. 20-ZOLL PANAMERA SPORT 9,5J X 20'' ET65 255/40 R20 101V XL M+S 11,5J X 20'' ET63 295/35 R20 105V XL M+S GT Silver Metallic MICHELIN ALL SEASON Not Together with Shim	970 044 600 13	1	PR:482
(8)	970 044 600 48	<p style="text-align: right;">also use:</p> D - MJ 2010>> - MJ 2013 Set of wheels, compl. 20-ZOLL PANAMERA SPORT 9,5J X 20'' ET65 255/40 R20 101V XL M+S 11,5J X 20'' ET63 295/35 R20 105V XL M+S GT Silver Metallic MICHELIN ALL SEASON Not Together with Shim	970 044 600 13	1	PR:482
9	970 044 602 71	<p style="text-align: right;">also use:</p> D - MJ 2014>> - MJ 2016 Set of wheels, compl. 20-ZOLL PANAMERA SPORT 9,5J X 20'' ET65 255/40 ZR20 (101Y) XL 11,5J X 20'' ET63 295/35 ZR20 (105Y) XL Silk-Gloss Platinum MICHELIN Included Hub cap Not Together with Shim	970 044 600 13	1	PR:-482
(9)	970 044 602 72	D - MJ 2010>> - MJ 2016 Set of wheels, compl. 20-ZOLL PANAMERA SPORT 9,5J X 20'' ET65 255/40 ZR20 (101Y) XL 11,5J X 20'' ET63 295/35 ZR20 (105Y) XL Silk-Gloss Platinum MICHELIN		1	PR:482

Model: TEQ 3 Model life 2010>>

Pos	Part Number	Description	Remark	Qty	Model
(9)	970 044 602 74	Included Hub cap Not Together with Shim D - MJ 2010>> - MJ 2013 Set of wheels, compl. 20-ZOLL PANAMERA SPORT 9,5J X 20'' ET65 255/40 ZR20 (101Y) XL 11,5J X 20'' ET63 295/35 ZR20 (105Y) XL Silk-Gloss Platinum MICHELIN		1	PR:482
10	970 044 602 59	Included Hub cap Not Together with Shim D - MJ 2014>> - MJ 2016 Set of wheels, compl. 20-ZOLL PANAMERA SPORT 9,5J X 20'' ET65 255/40 ZR20 (101Y) XL 11,5J X 20'' ET63 295/35 ZR20 (105Y) XL High-Gloss Black MICHELIN		1	PR:-482
(10)	970 044 602 60	Included Hub cap Not Together with Shim D - MJ 2010>> - MJ 2016 Set of wheels, compl. 20-ZOLL PANAMERA SPORT 9,5J X 20'' ET65 255/40 ZR20 (101Y) XL 11,5J X 20'' ET63 295/35 ZR20 (105Y) XL High-Gloss Black MICHELIN		1	PR:482
(10)	970 044 602 62	Included Hub cap Not Together with Shim D - MJ 2010>> - MJ 2013 Set of wheels, compl. 20-ZOLL PANAMERA SPORT 9,5J X 20'' ET65 255/40 ZR20 (101Y) XL 11,5J X 20'' ET63 295/35 ZR20 (105Y) XL High-Gloss Black MICHELIN		1	PR:482
11	970 044 602 63	Included Hub cap Not Together with Shim D - MJ 2014>> - MJ 2016 Set of wheels, compl.		1	PR:-482

Model: TEQ 3 Model life 2010>>

Pos	Part Number	Description	Remark	Qty	Model
(11)	970 044 602 64	20-ZOLL SPORT CLASSIC 9,5J X 20'' ET65 255/40 ZR20 (101Y) XL 11,5J X 20'' ET63 295/35 ZR20 (105Y) XL GT Silver Metallic MICHELIN Not Together with Shim also use: D - MJ 2010>> - MJ 2016 Set of wheels, compl.	970 044 600 20	1	PR:482
(11)	970 044 602 66	20-ZOLL PANAMERA SPORT 9,5J X 20'' ET65 255/40 ZR20 (101Y) XL 11,5J X 20'' ET63 295/35 ZR20 (105Y) XL GT Silver Metallic MICHELIN Not Together with Shim also use: D - MJ 2010>> - MJ 2013 Set of wheels, compl.	970 044 600 20	1	PR:482
12	970 044 602 67	20-ZOLL PANAMERA SPORT 9,5J X 20'' ET65 255/40 ZR20 (101Y) XL 11,5J X 20'' ET63 295/35 ZR20 (105Y) XL GT Silver Metallic MICHELIN Not Together with Shim also use: D - MJ 2014>> - MJ 2016 Set of wheels, compl.	970 044 600 20	1	PR:-482
(12)	970 044 602 68	20-ZOLL SPORT CLASSIC 9,5J X 20'' ET65 255/40 ZR20 (101Y) XL 11,5J X 20'' ET63 295/35 ZR20 (105Y) XL High-Gloss Black MICHELIN Included Hub cap Not Together with Shim D - MJ 2010>> - MJ 2016 Set of wheels, compl.		1	PR:482

Model: TEQ 3

Model life 2010>>

Pos	Part Number	Description	Remark	Qty	Model
(12)	970 044 602 70	Together with Shim D - MJ 2010>> - MJ 2013 Set of wheels, compl. 20-ZOLL PANAMERA SPORT 9,5J X 20'' ET65 255/40 ZR20 (101Y) XL 11,5J X 20'' ET63 295/35 ZR20 (105Y) XL High-Gloss Black MICHELIN Included Hub cap Not Together with Shim D - MJ 2014>> - MJ 2016		1	PR:482

Model: TEQ 3

Model life 2010>>



1



2



3



4

Model: TEQ 3 Model life 2010>>

Pos	Part Number	Description	Remark	Qty	Model
-		Gear wheel sets Winter D - MJ 2010>> - MJ 2016 All Gear wheel sets Not Together with Shim			Panamera G1
-		Attention PCCB only in conj. with: 20-ZOLL GTS, TURBO, TURBO S only in conj. with: 19/20-ZOLL PANAMERA, S, 4, 4S, DIESEL, S HYBRID			PR:450
1	970 044 600 57	Set of wheels, compl. 18-ZOLL PANAMERA 8J X 18'' ET59 245/50 R18 104V XL M&S 9J X 18'' ET53 275/45 R18 107V XL M&S silver NOKIAN also use: use if required:	970 044 600 11 970 044 600 09	1	PR:-482,-450 OHNE/NOT FOR Panamera GTS TURBO TURBO S
(1)	970 044 600 55	D - MJ 2010>> - MJ 2016 Set of wheels, compl. 18-ZOLL PANAMERA 8J X 18'' ET59 245/50 R18 100V M&S 9J X 18'' ET53 275/45 R18 103V M&S silver PIRELLI also use: use if required:	970 044 600 11 970 044 600 09	1	PR:-482,-450 OHNE/NOT FOR Panamera GTS TURBO TURBO S
(1)	970 044 600 58	D - MJ 2010>> - MJ 2016 Set of wheels, compl. 18-ZOLL PANAMERA 8J X 18'' ET59 245/50 R18 104V XL M&S 9J X 18'' ET53 275/45 R18 107V XL M&S silver NOKIAN also use: use if required:	970 044 600 11 970 044 600 09	1	PR:482,-450 OHNE/NOT FOR Panamera GTS TURBO TURBO S
(1)	970 044 600 42	D - MJ 2010>> - MJ 2013 Set of wheels, compl. 18-ZOLL PANAMERA 8J X 18'' ET59 245/50 R18 104V XL M&S 9J X 18'' ET53 275/45 R18 107V XL M&S silver NOKIAN also use: use if required:	970 044 600 11 970 044 600 09	1	PR:482,-450 OHNE/NOT FOR Panamera GTS TURBO TURBO S
(1)	970 044 600 56	D - MJ 2014>> - MJ 2016 Set of wheels, compl. 18-ZOLL PANAMERA		1	PR:482,-450

Model: TEQ 3 Model life 2010>>

Pos	Part Number	Description	Remark	Qty	Model
(1)	970 044 600 30	8J X 18'' ET59 245/50 R18 100V M&S 9J X 18'' ET53 275/45 R18 103V M&S silver PIRELLI also use: 970 044 600 11 use if required: 970 044 600 09 D - MJ 2010>> - MJ 2013 Set of wheels, compl. 18-ZOLL PANAMERA		1	OHNE/NOT FOR Panamera GTS TURBO TURBO S PR:482,-450
2	970 044 600 61	8J X 18'' ET59 245/50 R18 100V M&S 9J X 18'' ET53 275/45 R18 103V M&S silver PIRELLI also use: 970 044 600 11 use if required: 970 044 600 09 D - MJ 2014>> - MJ 2016 Set of wheels, compl. 18-ZOLL PANAMERA S		1	OHNE/NOT FOR Panamera GTS TURBO TURBO S PR:-482,-450
(2)	970 044 600 51	8J X 18'' ET59 245/50 R18 104V XL M&S 9J X 18'' ET53 275/45 R18 107V XL M&S silver NOKIAN also use: 970 044 600 11 use if required: 970 044 600 09 D - MJ 2010>> - MJ 2016 Set of wheels, compl. 18-ZOLL PANAMERA S		1	OHNE/NOT FOR Panamera GTS TURBO TURBO S PR:-482,-450
(2)	970 044 600 62	8J X 18'' ET59 245/50 R18 104V XL M&S 9J X 18'' ET53 275/45 R18 107V XL M&S silver NOKIAN also use: 970 044 600 11 use if required: 970 044 600 09 D - MJ 2010>> - MJ 2016 Set of wheels, compl. 18-ZOLL PANAMERA S		1	OHNE/NOT FOR Panamera GTS TURBO TURBO S PR:482,-450
(2)	970 044 600 20	8J X 18'' ET59 245/50 R18 104V XL M&S 9J X 18'' ET53 275/45 R18 107V XL M&S silver NOKIAN also use: 970 044 600 11 use if required: 970 044 600 09 D - MJ 2010>> - MJ 2013 Set of wheels, compl. 18-ZOLL PANAMERA S		1	OHNE/NOT FOR Panamera GTS TURBO TURBO S PR:482,-450

Model: TEQ 3 Model life 2010>>

Pos	Part Number	Description	Remark	Qty	Model
(2)	970 044 600 52	D - MJ 2014>> - MJ 2016 Set of wheels, compl. 18-ZOLL PANAMERA S 8J X 18'' ET59 245/50 R18 100V M&S 9J X 18'' ET53 275/45 R18 103V M&S silver PIRELLI also use: use if required:	970 044 600 11 970 044 600 09	1	PR:482,-450 OHNE/NOT FOR Panamera GTS TURBO TURBO S
(2)	970 044 600 32	D - MJ 2010>> - MJ 2013 Set of wheels, compl. 18-ZOLL PANAMERA S 8J X 18'' ET59 245/50 R18 100V M&S 9J X 18'' ET53 275/45 R18 103V M&S silver PIRELLI also use: use if required:	970 044 600 11 970 044 600 09	1	PR:482,-450 OHNE/NOT FOR Panamera GTS TURBO TURBO S
3	970 044 600 77	D - MJ 2014>> - MJ 2016 Set of wheels, compl. 19-ZOLL PANAMERA TURBO II 9J X 19'' ET60 255/45 R19 100V M&S 10J X 19'' ET61 285/40 R19 103V M&S silver CONTINENTAL also use: use if required:	2010-13 2014-16 970 044 600 14 970 044 600 10	1	PR:-482,-092
(3)	970 044 600 73	Set of wheels, compl. 19-ZOLL PANAMERA TURBO II 9J X 19'' ET60 255/45 R19 100V M&S 10J X 19'' ET61 285/40 R19 103V M&S silver PIRELLI also use: use if required:	2010-13 2014-16 970 044 600 14 970 044 600 10	1	PR:-482,-092
(3)	970 044 600 69	Set of wheels, compl. 19-ZOLL PANAMERA TURBO II 9J X 19'' ET60 255/45 R19 100V M&S 10J X 19'' ET61 285/40 R19 103V M&S silver MICHELIN also use: use if required:	2010-13 2014-16 970 044 600 14 970 044 600 10	1	PR:-482,-092
(3)	970 044 600 78	Set of wheels, compl. 19-ZOLL PANAMERA TURBO II 9J X 19'' ET60 255/45 R19 100V M&S 10J X 19'' ET61 285/40 R19 103V M&S silver CONTINENTAL also use: use if required:	970 044 600 14 970 044 600 10	1	PR:482

Model: TEQ 3 Model life 2010>>

Pos	Part Number	Description	Remark	Qty	Model
(3)	970 044 600 80	D - MJ 2010>> - MJ 2013 Set of wheels, compl. 19-ZOLL PANAMERA TURBO II 9J X 19'' ET60 255/45 R19 100V M&S 10J X 19'' ET61 285/40 R19 103V M&S silver CONTINENTAL	also use: 970 044 600 14 use if required: 970 044 600 10	1	PR:482,-092
(3)	970 044 600 74	D - MJ 2014>> - MJ 2016 Set of wheels, compl. 19-ZOLL PANAMERA TURBO II 9J X 19'' ET60 255/45 R19 100V M&S 10J X 19'' ET61 285/40 R19 103V M&S silver PIRELLI	also use: 970 044 600 14 use if required: 970 044 600 10	1	PR:482
(3)	970 044 600 76	D - MJ 2010>> - MJ 2013 Set of wheels, compl. 19-ZOLL PANAMERA TURBO II 9J X 19'' ET60 255/45 R19 100V M&S 10J X 19'' ET61 285/40 R19 103V M&S silver PIRELLI	also use: 970 044 600 14 use if required: 970 044 600 10	1	PR:482,-092
(3)	970 044 600 70	D - MJ 2014>> - MJ 2016 Set of wheels, compl. 19-ZOLL PANAMERA TURBO II 9J X 19'' ET60 255/45 R19 100V M&S 10J X 19'' ET61 285/40 R19 103V M&S silver MICHELIN	also use: 970 044 600 14 use if required: 970 044 600 10	1	PR:482
(3)	970 044 600 72	D - MJ 2010>> - MJ 2013 Set of wheels, compl. 19-ZOLL PANAMERA TURBO II 9J X 19'' ET60 255/45 R19 100V M&S 10J X 19'' ET61 285/40 R19 103V M&S silver MICHELIN	also use: 970 044 600 14 use if required: 970 044 600 10	1	PR:482,-092
4	970 044 600 89	D - MJ 2014>> - MJ 2016 Set of wheels, compl. 20-ZOLL RS SPYDER DESIGN 9,5J X 20'' ET65 255/40 R20 101V XL M&S 10,5J X 20'' ET65 285/35 R20 104V XL M&S silver		1	PR:-482

Model: TEQ 3 Model life 2010>>

Pos	Part Number	Description	Remark	Qty	Model
(4)	970 044 600 85	CONTINENTAL also use: use if required: D - MJ 2010>> - MJ 2016 Set of wheels, compl. 20-ZOLL RS SPYDER DESIGN 9,5J X 20'' ET65 255/40 R20 101V XL M&S 10,5J X 20'' ET65 285/35 R20 104V XL M&S silver PIRELLI	970 044 600 14 970 044 600 10	1	PR:-482
(4)	970 044 600 81	CONTINENTAL also use: use if required: D - MJ 2010>> - MJ 2016 Set of wheels, compl. 20-ZOLL RS SPYDER DESIGN 9,5J X 20'' ET65 255/40 R20 101V XL M&S 10,5J X 20'' ET65 285/35 R20 104V XL M&S silver MICHELIN	970 044 600 14 970 044 600 10	1	PR:-482
(4)	970 044 600 90	CONTINENTAL also use: use if required: D - MJ 2010>> - MJ 2016 Set of wheels, compl. 20-ZOLL RS SPYDER DESIGN 9,5J X 20'' ET65 255/40 R20 101V XL M&S 10,5J X 20'' ET65 285/35 R20 104V XL M&S silver CONTINENTAL	970 044 600 14 970 044 600 10	1	PR:482
(4)	970 044 600 92	CONTINENTAL also use: use if required: D - MJ 2010>> - MJ 2013 Set of wheels, compl. 20-ZOLL RS SPYDER DESIGN 9,5J X 20'' ET65 255/40 R20 101V XL M&S 10,5J X 20'' ET65 285/35 R20 104V XL M&S silver CONTINENTAL	970 044 600 14 970 044 600 10	1	PR:482
(4)	970 044 600 86	CONTINENTAL also use: use if required: D - MJ 2014>> - MJ 2016 Set of wheels, compl. 20-ZOLL RS SPYDER DESIGN 9,5J X 20'' ET65 255/40 R20 101V XL M&S 10,5J X 20'' ET65 285/35 R20 104V XL M&S silver PIRELLI	970 044 600 14 970 044 600 10	1	PR:482
(4)	970 044 600 88	CONTINENTAL also use: use if required: D - MJ 2010>> - MJ 2013 Set of wheels, compl. 20-ZOLL RS SPYDER DESIGN 9,5J X 20'' ET65 255/40 R20 101V XL M&S	970 044 600 14 970 044 600 10	1	PR:482

Model: TEQ 3

Model life 2010>>

Pos	Part Number	Description	Remark	Qty	Model
(4)	970 044 600 82	10,5J X 20'' ET65 285/35 R20 104V XL M&S silver PIRELLI also use: 970 044 600 14 use if required: 970 044 600 10 D - MJ 2014>> - MJ 2016 Set of wheels, compl. 20-ZOLL RS SPYDER DESIGN 9,5J X 20'' ET65 255/40 R20 101V XL M&S 10,5J X 20'' ET65 285/35 R20 104V XL M&S silver MICHELIN		1	PR:482
(4)	970 044 600 84	also use: 970 044 600 14 use if required: 970 044 600 10 D - MJ 2010>> - MJ 2013 Set of wheels, compl. 20-ZOLL RS SPYDER DESIGN 9,5J X 20'' ET65 255/40 R20 101V XL M&S 10,5J X 20'' ET65 285/35 R20 104V XL M&S silver MICHELIN		1	PR:482
		also use: 970 044 600 14 use if required: 970 044 600 10 D - MJ 2014>> - MJ 2016			

Model: TEQ 3

Model life 2010>>



Model: TEQ 3 Model life 2010>>

Pos	Part Number	Description	Remark	Qty	Model
1	970 044 600 09	Snow chains 18-ZOLL FUER 275/45 R18 M+S NUR AN HINTERACHSE NICHT I. V. M. DISTANZSCH. D - MJ 2010>> - MJ 2016	10-16 17-	1	Panamera/4 S/4S/Diesel S Hybrid
(1)	970 044 600 10	Snow chains 19-ZOLL 20-ZOLL FUER 285/40 R19 M+S FUER 285/35 R20 M+S NUR AN HINTERACHSE NICHT I. V. M. DISTANZSCH. D - MJ 2010>> - MJ 2016		1	Panamera/4 S/4S/Diesel S Hybrid/GTS Turbo/S
-		Inst. & Conv. Instructions Group 4 4439 (34/16) Attention			
2	971 044 690 A	Snow chains 19-ZOLL FUER 295/40 R19 M+S NUR AN HINTERACHSE NICHT I. V. M. DISTANZSCH. D - MJ 2017>>		1	
(2)	971 044 690 B	Snow chains 20-ZOLL 21-ZOLL FUER 315/35 R20 M+S FUER 315/30 R21 M+S NUR AN HINTERACHSE NICHT I. V. M. DISTANZSCH. D - MJ 2017>>		1	

Model: TEQ 3

Model life 2010>>

1

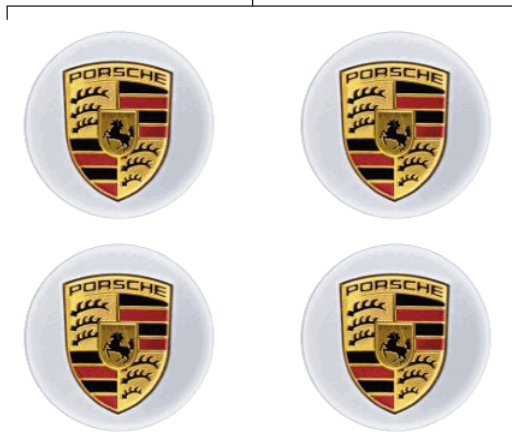

2



3



Model: TEQ 3 Model life 2010>>

Pos	Part Number	Description	Remark	Qty	Model
1	955 044 600 11	Hub cap D - MJ 2010>> Hub cap Set silver Porsche crest Coloured for Set of wheels, compl. 18-ZOLL PANAMERA 18-ZOLL PANAMERA S 19-ZOLL PANAMERA		1	
(1)	955 044 600 09	Hub cap Set silver Porsche crest Coloured for Set of wheels, compl. 19-ZOLL PANAMERA S		1	
(1)	970 044 600 14	1 set wheel trim caps Brilliant chrome finish Porsche crest Coloured for Set of wheels, compl. 19-ZOLL PANAMERA TURBO 19-ZOLL PANAMERA TURBO II 19-ZOLL PANAMERA CLASSIC 19-ZOLL PANAMERA DESIGN II 20-ZOLL RS SPYDER 20-ZOLL PANAMERA TURBO 20-ZOLL PANAMERA DESIGN 21-ZOLL SPORT DESIGN		1	
(1)	991 044 600 20	1 set wheel trim caps GT Silver Metallic Porsche crest Coloured for Set of wheels, compl. 20-ZOLL SPORT CLASSIC II		1	
(1)	970 044 600 13	1 set wheel trim caps GT Silver Metallic Porsche crest Coloured for Set of wheels, compl. 20-ZOLL PANAMERA SPORT		1	
(1)	970 044 600 12	1 set wheel trim caps Titanium grey Porsche crest Coloured for Set of wheels, compl. 20-ZOLL 911 TURBO II		1	
(1)	991 044 600 23	1 set wheel trim caps Titanium Dark Porsche crest Coloured for Set of wheels, compl. 20-ZOLL 911 TURBO III		1	

Model: TEQ 3

Model life 2010>>

Pos	Part Number	Description	Remark	Qty	Model
(1)	000 044 607 32	21-ZOLL 911 TURBO DESIGN 1 set wheel trim caps Platinum Silver Porsche crest Coloured for Set of wheels, compl. 20-ZOLL EXCLUSIVE DESIGN 21-ZOLL EXCLUSIVE DESIGN		1	
2	991 044 600 21	1 set wheel trim caps Silk-Gloss Platinum Porsche crest Coloured for Set of wheels, compl. 20-ZOLL PANAMERA SPORT 20-ZOLL EXCLUSIVE DESIGN 21-ZOLL SPORT DESIGN 21-ZOLL EXCLUSIVE DESIGN Silk-Gloss Platinum		1	
3	997 044 602 97	1 set wheel trim caps Black Porsche crest Coloured for Set of wheels, compl. 20-ZOLL SPORT CLASSIC II Black		1	
(3)	997 044 600 47	1 set wheel trim caps Black Porsche crest Coloured for Set of wheels, compl. 20-ZOLL PANAMERA SPORT Black		1	
(3)	000 044 607 33	1 set wheel trim caps Black Porsche crest Coloured for Set of wheels, compl. 20-ZOLL EXCLUSIVE DESIGN 21-ZOLL EXCLUSIVE DESIGN 21-ZOLL SPORT DESIGN Black		1	
(3)	000 044 607 34	1 set wheel trim caps Jet Black Metallic Porsche crest Coloured for Set of wheels, compl. 21-ZOLL SPORT DESIGN 21-ZOLL EXCLUSIVE DESIGN Jet Black Metallic		1	

Model: TEQ 3

Model life 2010>>



1



2



3



4



5



6



7

Model: TEQ 3 Model life 2010>>

Pos	Part Number	Description	Remark	Qty	Model
-		Wheels Gear wheel sets D - MJ 2017>> Information Manufacturer Approval Wheels and tyres in Piwis See main group 4 suspension Attention	Summer		Panamera G2
-		All Gear wheel sets not in combination with: Shim			
1	971 044 660 B	Set of wheels, compl. 20-ZOLL PANAMERA TURBO 9,5 J X 20" ET71 275/40 ZR20 106(Y) XL 11,5 J X 20" ET68 315/35 ZR20 110(Y) XL silver MICHELIN		1	ohne/not for Turbo S E-Hybrid
		also use:	970 044 600 14		
2	971 044 660 F	Set of wheels, compl. 20-ZOLL PANAMERA DESIGN 9,5 J X 20" ET71 275/40 ZR20 106(Y) XL 11,5 J X 20" ET68 315/35 ZR20 110(Y) XL silver MICHELIN		1	ohne/not for Turbo S E-Hybrid
		also use:	970 044 600 14		
3	971 044 660 G	Set of wheels, compl. 21-ZOLL 911 TURBO DESIGN 9,5 J X 21" ET71 275/35 ZR21 103(Y) XL 11,5 J X 21" ET69 315/30 ZR21 105(Y) XL two-colour PIRELLI		1	ohne/not for Turbo S E-Hybrid
		also use:	991 044 600 23		
(3)	971 044 660 L	Set of wheels, compl. 21-ZOLL 911 TURBO DESIGN 9,5 J X 21" ET71 275/35 ZR21 103(Y) XL 11,5 J X 21" ET69 325/30 ZR21 108(Y) two-colour MICHELIN		1	Turbo S E-Hybrid -"CN.", -"BR."
		also use:	991 044 600 23		
4	971 044 660 E	Set of wheels, compl. 21-ZOLL PANAMERA Sport Design package 9,5 J X 21" ET71 275/35 ZR21 103(Y) XL 11,5 J X 21" ET69 315/30 ZR21 105(Y) XL silver PIRELLI		1	ohne/not for Turbo S E-Hybrid
		also use:	970 044 600 14		
(4)	971 044 660 K	Set of wheels, compl. 21-ZOLL PANAMERA		1	-"CN." Turbo S

Model: TEQ 3 Model life 2010>>

Pos	Part Number	Description	Remark	Qty	Model
5	971 044 660 H	Sport Design package 9,5 J X 21" ET71 275/35 ZR21 103(Y) XL 11,5 J X 21" ET69 325/30 ZR21 108(Y) silver MICHELIN also use:	970 044 600 14	1	E-Hybrid
(5)	971 044 660 M	Set of wheels, compl. 21-ZOLL EXCLUSIVE DESIGN 9,5 J X 21" ET71 275/35 ZR21 103(Y) XL 11,5 J X 21" ET69 315/30 ZR21 105(Y) XL silver PIRELLI also use:	000 044 607 32	1	ohne/not for Turbo S E-Hybrid -"CN.", -"BR."
6	971 044 660 I	Set of wheels, compl. 21-ZOLL EXCLUSIVE DESIGN 9,5 J X 21" ET71 275/35 ZR21 103(Y) XL 11,5 J X 21" ET69 325/30 ZR21 108(Y) silver MICHELIN also use:	000 044 607 32	1	ohne/not for Turbo S E-Hybrid -"CN.", -"BR."
(6)	971 044 660 N	Set of wheels, compl. 21-ZOLL EXCLUSIVE DESIGN 9,5 J X 21" ET71 275/35 ZR21 103(Y) XL 11,5 J X 21" ET69 325/30 ZR21 108(Y) Silk-Gloss Platinum Included Hub cap PIRELLI		1	Turbo S E-Hybrid -"CN.", -"BR."
7	971 044 660 J	Set of wheels, compl. 21-ZOLL EXCLUSIVE DESIGN 9,5 J X 21" ET71 275/35 ZR21 103(Y) XL 11,5 J X 21" ET69 315/30 ZR21 105(Y) XL Black PIRELLI Included Hub cap PIRELLI		1	ohne/not for Turbo S E-Hybrid -"CN.", -"BR."
(7)	971 044 660 O	Set of wheels, compl. 21-ZOLL EXCLUSIVE DESIGN 9,5 J X 21" ET71 275/35 ZR21 103(Y) XL 11,5 J X 21" ET69 325/30 ZR21 108(Y)		1	Turbo S E-Hybrid -"CN.", -"BR."

Model: TEQ 3

Model life 2010>>

Pos	Part Number	Description	Remark	Qty	Model
		Black MICHELIN Included Hub cap			

Model: TEQ 3

Model life 2010>>



1



2



3



4



5



6



7

Model: TEQ 3 Model life 2010>>

Pos	Part Number	Description	Remark	Qty	Model
1	971 044 600 A	Wheels Gear wheel sets Winter D - MJ 2017>> Set of wheels, compl. 19-ZOLL PANAMERA 9,0J X 19'' ET64 265/45 R19 M&S 10,5J X 19'' ET62 295/40 R19 M&S silver MICHELIN		1	Panamera G2 PR:7K3 OHNE/NOT FOR TURBO
			also use: 970 044 600 11		
(1)	971 044 601 A	Set of wheels, compl. 19-ZOLL PANAMERA 9,0J X 19' ET64 265/45 R19 M&S 10,5J X 19'' ET62 295/40 R19 M&S silver CONTINENTAL	Not for: PCCB use if required: 971 044 690 A	1	PR:7K3 OHNE/NOT FOR TURBO
			also use: 970 044 600 11		
2	971 044 600 B	Set of wheels, compl. 20-ZOLL PANAMERA TURBO 9,5J X 20'' ET71 275/40 R20 M&S 10,5J X 20'' ET71 315/35 R20 M&S silver MICHELIN	Not for: PCCB use if required: 971 044 690 A	1	PR:7K3
			also use: 000 044 607 03 use if required: 971 044 690 B		
3	971 044 600 C	Set of wheels, compl. 20-ZOLL PANAMERA EXCLUSIVE DESIGN 9,5J X 20'' ET71 275/40 R20 M&S 10,5J X 20'' ET71 315/35 R20 M&S Platinum Silver MICHELIN	Not for: PCCB use if required: 971 044 690 B	1	PR:7K3
			also use: 000 044 607 32 use if required: 971 044 690 B		
4	971 044 600 D	Set of wheels, compl. 20-ZOLL PANAMERA EXCLUSIVE DESIGN 9,5J X 20'' ET71 275/40 R20 M&S 10,5J X 20'' ET71 315/35 R20 M&S Silk-Gloss Platinum MICHELIN Included Hub cap	Not for: PCCB use if required: 971 044 690 B	1	PR:7K3
			also use: 971 044 690 B		
5	971 044 600 E	Set of wheels, compl. 21-ZOLL PANAMERA	Not for: PCCB use if required: 971 044 690 B	1	PR:7K3

Model: TEQ 3 Model life 2010>>

Pos	Part Number	Description	Remark	Qty	Model
-		Sport Design package 9,5J X 21'' ET71 275/35 R21 M&S 10,5J X 21'' ET71 315/30 R21 M&S silver PIRELLI			
			also use: 970 044 600 14 use if required: 971 044 690 B		
6	971 698 025 B	Wheels Individual parts Only for replacement Alloy wheel EXCLUSIVE DESIGN Front axle 9,5J X 20" ET71 D - MJ 2017>>		1	
(6)	971 698 025 B OU7 971 698 025 C	Platinum Silver Alloy wheel EXCLUSIVE DESIGN Rear axle 10,5J X 20" ET71 D - MJ 2017>>		1	
7	971 698 025 C OU7 971 698 025 B	Platinum Silver Alloy wheel EXCLUSIVE DESIGN Front axle 9,5J X 20" ET71 D - MJ 2017>>		1	
(7)	971 698 025 B OB5 971 698 025 C	Silk-Gloss Platinum Alloy wheel EXCLUSIVE DESIGN Rear axle 10,5J X 20" ET71 D - MJ 2017>>		1	
	971 698 025 C OB5	Silk-Gloss Platinum			

Model: TEQ 3

Model life 2010>>

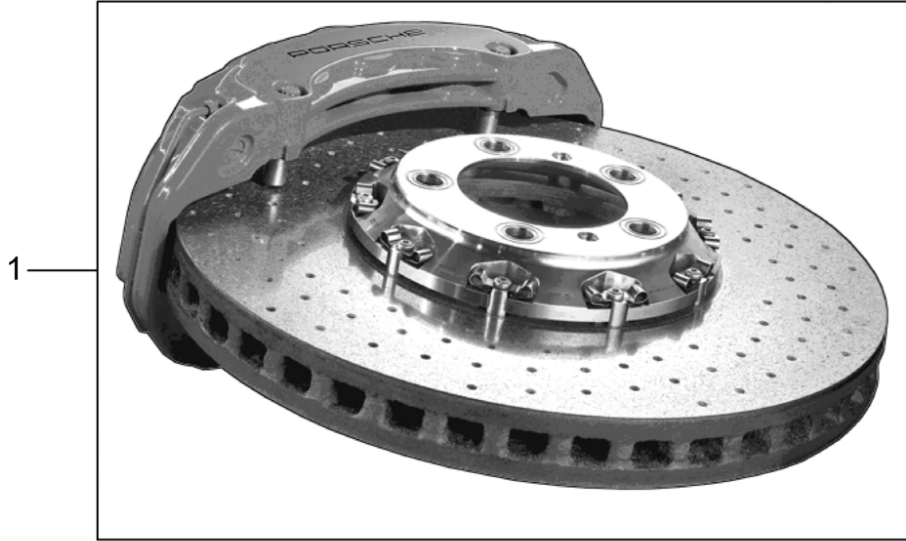

Model: TEQ 3

Model life 2010>>

Pos	Part Number	Description	Remark	Qty	Model
-		Brake PCCB D - MJ 2010>> - MJ 2013 Inst. & Conv. Instructions Panamera Turbo Group 4 4701 (8/10) Attention			Panamera Turbo
1	970 044 605 00	Brakes PCCB Set		1	PR:-450

Model: TEQ 3

Model life 2010>>

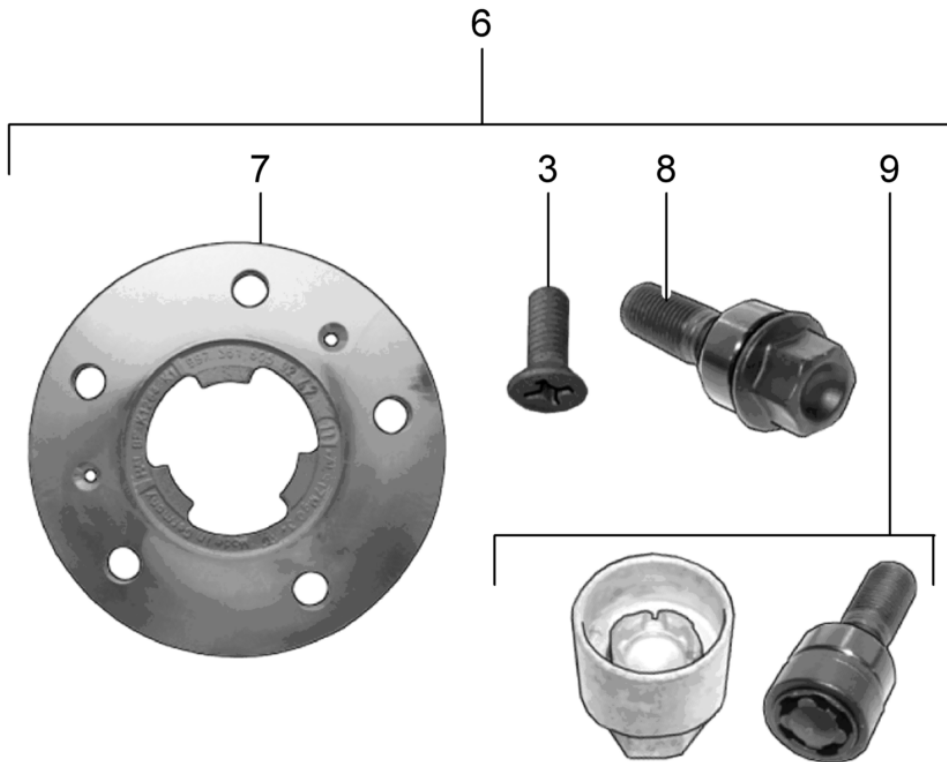
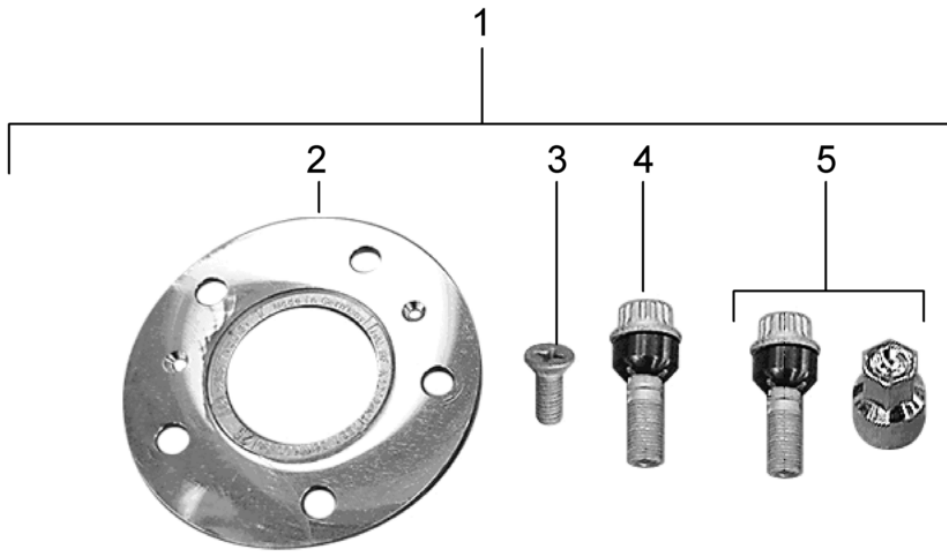

Model: TEQ 3 Model life 2010>>

Pos	Part Number	Description	Remark	Qty	Model
-		Shim 5 MM D - MJ 2010>> - MJ 2016 Inst. & Conv. Instructions Panamera Group 4 4413 (43/09) Attention			alle
1	970 044 500 00	Spacer ring 5 MM Set F 97-AL040 633>> F 97-AL080 337>> Not for: Vehicle Ident. No. F 97AL0 40706 F 97AL0 80345 F 97AL0 80373 Discontinued part		1	S Turbo S Turbo Turbo PR: -XRW - "J..", - "DK.", - "SF.", - "GB.", - "RUS", - "MCY"
-		Set comprising:			
2	997 361 605 90	Spacer ring		2	5 mm
3	900 269 106 01	countersunk bolt		4	M6 x 16
4	997 361 980 07	Wheel bolt silver		16	M14x1,5x49
5	997 361 980 10	Set Anti-theft protection Wheel bolt silver		1	M14x1,5x49
(1)	970 044 500 01	Spacer ring 5 MM Set F 97-AL040 633>> F 97-AL080 337>> Not for: Vehicle Ident. No. F 97AL0 40706 F 97AL0 80345 F 97AL0 80373		1	S Turbo S Turbo Turbo PR: -XRW - "J.."
-		Inst. & Conv. Instructions Panamera Group 4 4413 (7/13) Attention			alle
6	970 044 500 02	Spacer ring 5 MM Set F 97-AL040 633>> F 97-AL080 337>> Not for: Vehicle Ident. No. F 97AL0 40706 F 97AL0 80345 F 97AL0 80373		1	S Turbo S Turbo Turbo

Model: TEQ 3

Model life 2010>>

Pos	Part Number	Description	Remark	Qty	Model
-		Set comprising:			PR: -XRW - "J.."
7	997 361 605 92	Spacer ring		2	5 mm
3	900 269 106 01	countersunk bolt		4	M6 x 16
8	WHT 004 676 A	Wheel bolt Black		16	M14x1,5x49
9	991 361 980 00	1 set wheel studs, anti-theft Wheel bolt Black		1	M14X1,5X49

Model: TEQ 3

Model life 2010>>

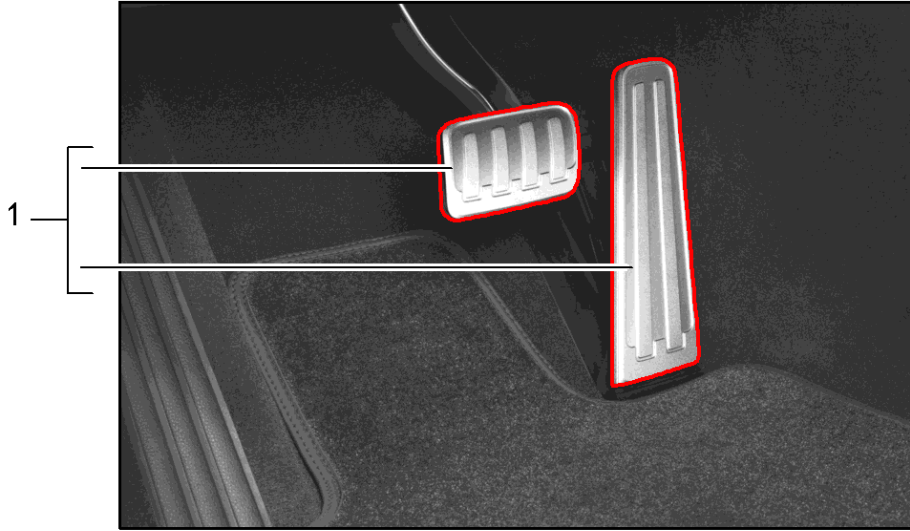

Model: TEQ 3 Model life 2010>>

Pos	Part Number	Description	Remark	Qty	Model
1	991 044 700 01	Pedal cap aluminium D - MJ 2010>> Pedal cap Set		1	PR:249,250, 099
1	970 044 700 00	Not for: Pedal cap Set	Hybrid	1	PR:249,250, 098
		with:			
1	970 044 700 01	Foot rest Not for: Pedal cap Set	Hybrid Hybrid	1	PR:249,098
		with:			
1	970 044 700 02	Foot rest Pedal cap Set	Hybrid	1	PR:249,099
(1)	991 044 700 03	Pedal cap Set		1	PR:480

Model: TEQ 3

Model life 2010>>

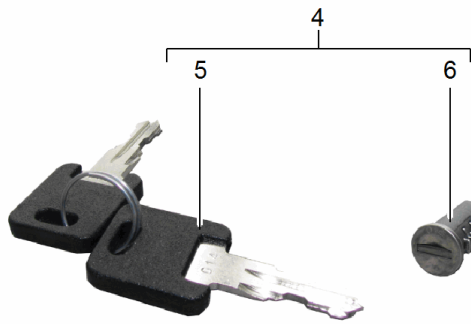
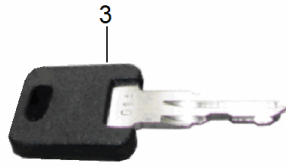
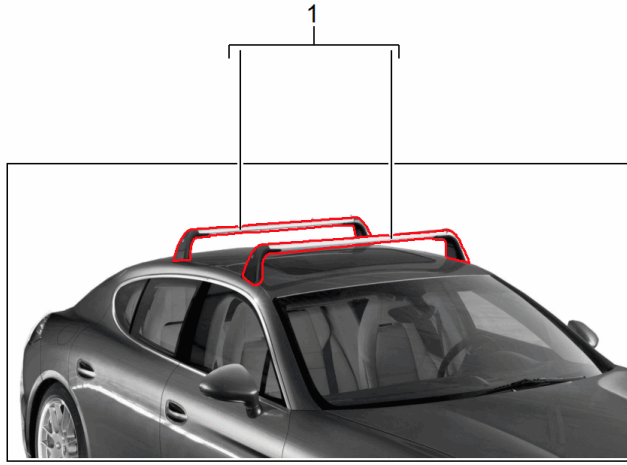

Model: TEQ 3 Model life 2010>>

Pos	Part Number	Description	Remark	Qty	Model
-		Roof carrier	10-16		OHNE/NOT FOR EXECUTIVE
-		Operating instructions	17-		
-		Panamera			alle
1	970 801 111 00	Attention Roof rack Main support Set		1	
(1)	971 860 159	D - MJ 2010>> - MJ 2016 Roof carrier Main support Set		1	PR:0E1
(1)	974 860 159	D - MJ 2017>> Roof carrier Main support Set		1	SportTurismo
2	974 860 159 9B9 955 801 385 00	D - MJ 2017>> Black Protective rubber Profile strip		1	1020 mm
3	955 044 000 59	D - MJ 2010>> - MJ 2016 key Set		1	
4	970 801 411 00	Roof rack State lock number D - MJ 2010>> - MJ 2016 Set of locks		1	
-		Roof rack D - MJ 2010>> - MJ 2016 Set			
5		comprising: key		2	
6		D - MJ 2010>> - MJ 2016 Lock cylinders		1	
(2)	971 863 486	D - MJ 2010>> - MJ 2016 Protective rubber Profile strip		1	
(4)	971 861 163	D - MJ 2017>> Set of locks comprising: Lock cylinders		1	
7	971 071 712	key D - MJ 2017>> Torque wrench		1	
8	971 860 131	D - MJ 2017>> Cover cap		4	
9	971 860 757	D - MJ 2017>> Tool Cover cap		1	
		D - MJ 2017>>			

Model: TEQ 3

Model life 2010>>

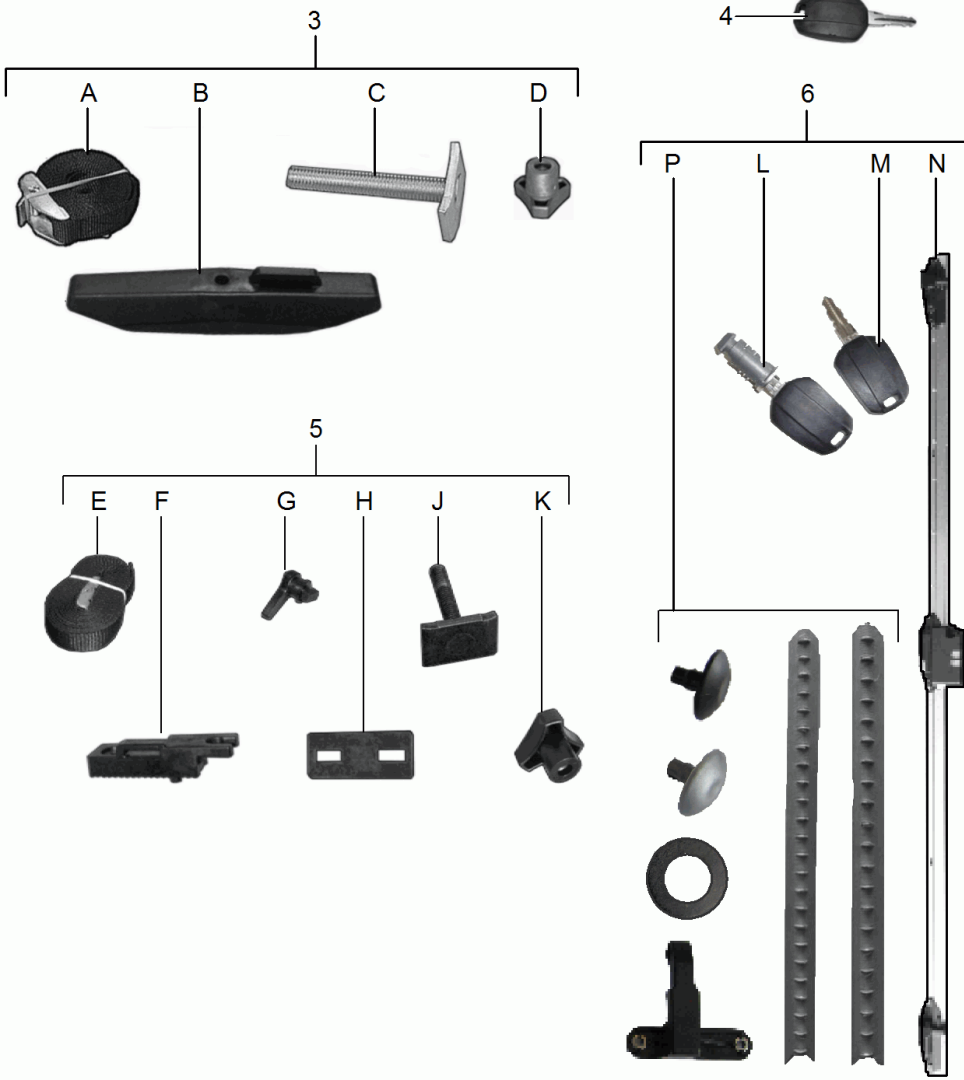

Model: TEQ 3 Model life 2010>>

Pos	Part Number	Description	Remark	Qty	Model
-		roof box D - MJ 2010>> Not for: Loading aid 955.044.000.04			Panamera
-		Technical information Panamera Group 6 6692 (28/14; 20/14; 4/09) Attention			alle
1	958 044 000 12	roof box 520 Black		1	PR:549
(1)	958 044 000 13	roof box 520 Platinum satin-matt		1	PR:549
2	958 044 000 26	roof box 320 Platinum satin-matt		1	PR:549
(2)	958 044 000 25	roof box 320 Black		1	PR:549
(2)	955 044 002 15	roof box Narrow silver		1	PR:549
(2)	955 044 000 47	roof box Narrow Discontinued part		1	PR:549
3	955 044 002 13	Assembly kit for roof box 955.044.002.12 comprising: tensioning strap clamping piece Screw bolt Nut Inst. & Conv. Instructions Attention	(Pos. A) (Pos. B) (Pos. C) (Pos. D)	3 4 4 4	M8x55 M8
(3)	958 044 000 21	Assembly kit for roof box 958.044.000.12 958.044.000.13 958.044.000.25 958.044.000.26 comprising: tensioning strap clamping piece Screw bolt Nut Inst. & Conv. Instructions Attention	(Pos. A) (Pos. B) (Pos. C) (Pos. D)	3 4 4 4	M8x55 M8
4	955 044 000 59	key for roof box State lock number		1	alle
5	955 044 000 48	Assembly kit for roof box 955.044.000.12 955.044.000.47 955.044.002.15		1	

Model: TEQ 3 Model life 2010>>

Pos	Part Number	Description	Remark	Qty	Model
		comprising:			
		Belt	(Pos. E)	2	
		Adapter	(Pos. F)	4	
		Screw bolt	(Pos. G)	4	M6x37
		Nut	(Pos. H)	4	M6
		Seal	(Pos. J)	4	
		clamping piece	(Pos. K)	4	
		Technical information			
		Attention			
		Discontinued part			
6	955 044 000 49	repair set		1	
		lock			
		for			
		roof box			
		955.044.000.12			
		955.044.002.15			
		comprising:			
		lock		1	(Pos. L)
		key		2	(Pos. M)
		strip		1	(Pos. N)
		Fasteners			(Pos. L)
(6)	958 044 000 20	repair set		1	
		lock			
		for			
		roof box			
		955.044.002.12			
		958.044.000.12			
		958.044.000.13			
		958.044.000.25			
		958.044.000.26			
		comprising:			
		lock		1	(Pos. L)
		key		2	(Pos. M)
		strip		1	(Pos. N)
		Fasteners			(Pos. P)
-	955 044 000 63	Support		1	
		Cover			
		roof box			
		955.044.000.12			
		955.044.002.12			
		958.044.000.12			
		958.044.000.13			

Model: TEQ 3

Model life 2010>>

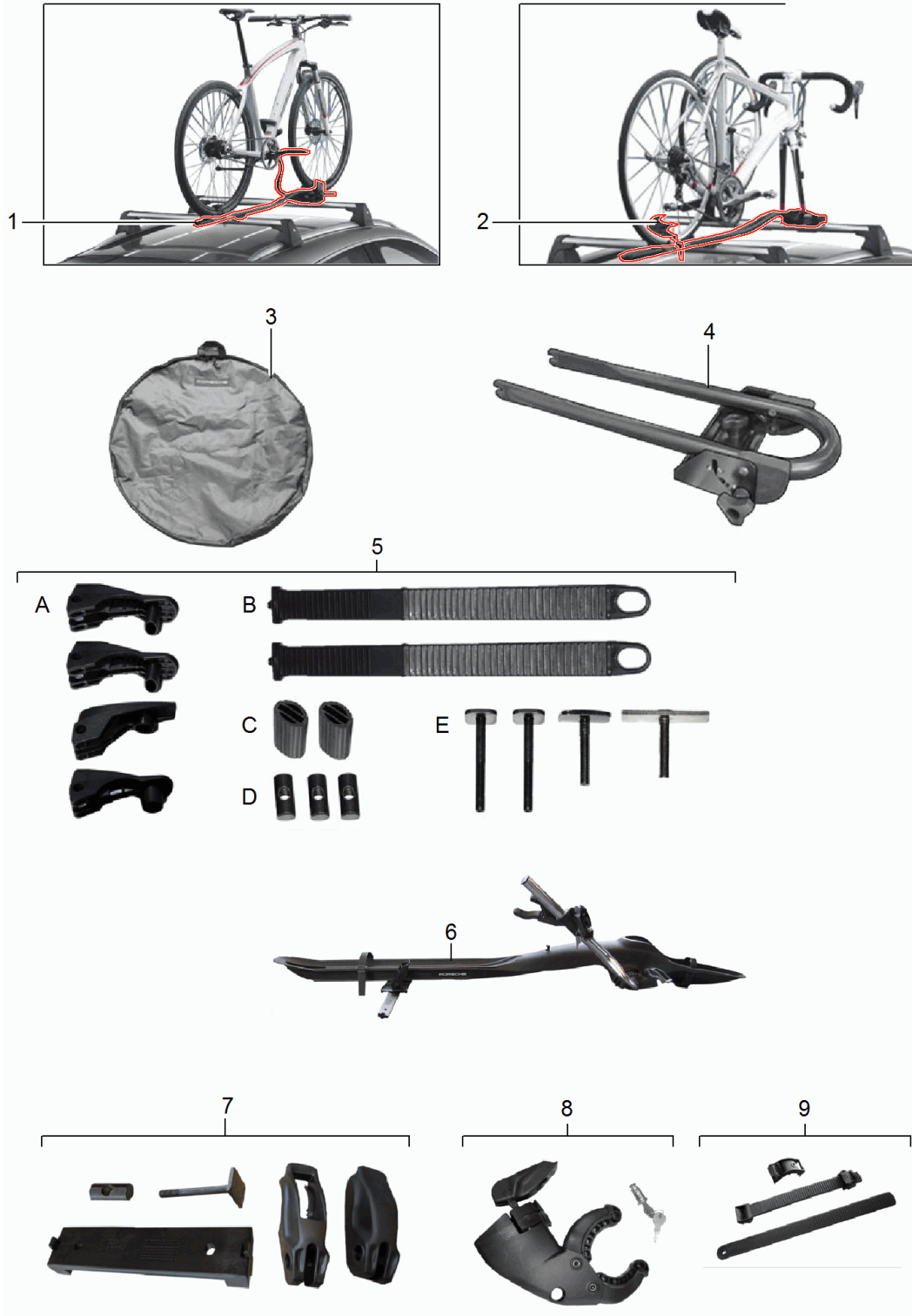

Model: TEQ 3 Model life 2010>>

Pos	Part Number	Description	Remark	Qty	Model
-		Bike stand Roof rack D - MJ 2010>> Technical information Panamera Group 6 6692 (38/14) 6692 (42/14) Attention			Panamera alle
1	95B 044 800 06	Bike stand Set - bike carrier		1	PR:549
2	95B 044 800 08	Bike stand Racing bike		1	PR:549,-K8D
		with:			
(2)	95B 044 800 09	Pocket 95B 044 800 34 Bike stand Racing bike		1	PR:549,-K8D
		with:			
-		Bracket 95B 044 800 35 Only for replacement			
3	95B 044 800 34	Pocket for Bike stand Racing bike		1	
4	95B 044 800 35	Bracket for Bike stand Racing bike		1	
5	95B 044 800 36	1 set attachment parts for Bike stand Set - bike carrier and Racing bike		1	
(5)		comprising: angled bracket tensioning strap Protective rubber Threaded pin Pin Pin Pin	(Pos. A) (Pos. B) (Pos. C) (Pos. D) (Pos. E) (Pos. E) (Pos. E)	4 2 2 3 2 1 1	M6 M6x60 M6x40 M6x35
-		Technical information Panamera Group 6 6692 (6/03) Attention			alle
6	955 044 002 66	Carrier Bike Set		1	
7	955 044 000 51	Discontinued part repair set for Carrier 955.044.002.66		1	
(7)		Set comprising: Adapter Threaded pin Pin Pin	front rear	1 3 2 1	M6 M6 x 55 M6 x 40

Model: TEQ 3 Model life 2010>>

Pos	Part Number	Description	Remark	Qty	Model
8	955 044 000 56	Pin angled bracket angled bracket Clutch with: Lock cylinders Set for Carrier 955.044.002.66		1 2 1 1	M6 x 25
9	955 044 000 80	Holding strap Bike Carrier Set		1	

Model: TEQ 3

Model life 2010>>



Model: TEQ 3 Model life 2010>>

Pos	Part Number	Description	Remark	Qty	Model
-		Bike stand for Tow hitch D - MJ 2010>> Operating instructions			
-		Bike stand Attention Only for vehicles with Tow hitch Connector 13-pin			
1	95B 044 800 07	Carrier Bike stand Tow hitch without:	lhd	1	PR:L0L -"USA", -"J..", -"CDN"
(1)	95B 044 800 11	Heat protection Not Together with Supplement set use if required:	955 044 000 86	1	PR:L0R -"USA", -"J..", -"CDN"
7	955 044 000 86	Carrier Bike stand Tow hitch without:	rh	1	PR:L0L -"USA", -"J..", -"CDN"
7	955 044 000 86	Heat protection Not Together with Supplement set use if required:	955 044 000 86	1	-"USA", -"J..", -"CDN"
2	955 044 000 59	Heat insulation for 955.044.000.60 95B.044.800.07 95B.044.800.11 Set comprising: 2 X 955.044.000.85		1	-"USA", -"J..", -"CDN"
2	955 044 000 59	key for 95B.044.800.07 95B.044.800.11		1	-"USA", -"J..", -"CDN"
-		State lock number Only for replacement			
3	95B 044 800 50	tensioning strap for Bike stand Tow hitch		1	-"USA", -"J..", -"CDN"
4	95B 044 800 51	95B.044.800.07 95B.044.800.11 Closing element tensioning strap for Bike stand Tow hitch		1	-"USA", -"J..", -"CDN"
5	95B 044 800 52	95B.044.800.07 95B.044.800.11 Licence plate holder		1	-"USA", -"J..", -"CDN"
		Bike stand Tow hitch 95B.044.800.07			

Model: TEQ 3 Model life 2010>>

Pos	Part Number	Description	Remark	Qty	Model
6	95B 044 800 53	95B.044.800.11 Lamp Set Included Wire set for Bike stand Tow hitch	lhd	1	PR:L0L -"USA", -"J..", -"CDN"
(6)	95B 044 800 57	95B.044.800.07 Lamp Set Included Wire set for Bike stand Tow hitch	rhd	1	PR:L0R -"USA", -"J..", -"CDN"
8	955 044 000 60	95B.044.800.11 Carrier Bike stand Included	lhd	1	PR:L0L -"USA", -"J..", -"CDN"
(7)	955 044 000 85	Heat protection Heat insulation for 955.044.000.60 Individual parts Only for replacement	lhd	2 1	PR:L0L -"USA", -"J..", -"CDN"
9	955 044 000 61	Supplement set 3. BIKE for 955.044.000.60	lhd	1	PR:L0L -"USA", -"J..", -"CDN"
10	955 044 000 82	Replacement key for 955.044.000.60	lhd	1	PR:L0L -"USA", -"J..", -"CDN"
11	955 044 000 83	Set of fastening parts Only for replacement	lhd	1	PR:L0L -"USA", -"J..", -"CDN"
12	955 044 000 84	Diffusor lens Back-up light Only for replacement	lhd	1	PR:L0L -"USA", -"J..", -"CDN"

Model: TEQ 3

Model life 2010>>



Model: TEQ 3

Model life 2010>>

Pos	Part Number	Description	Remark	Qty	Model
1	95B 044 800 10	Ski holder Snowboard holder ski and snowboard holder Loading aid Integrated		1	PR:549
2	95B 044 800 37	1 set attachment parts for Ski holder Snowboard holder comprising: Pin Hexagon nut Spring washer Plastic washer		1	
3	955 044 000 59	key State lock number		4 4 4 4 1	M6x16 M6 12 x 6,4 25 x 6,5

Model: TEQ 3

Model life 2010>>

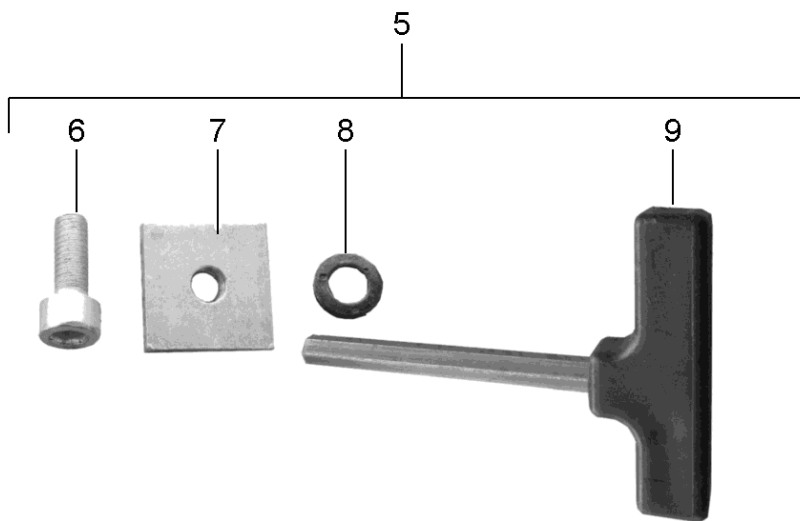
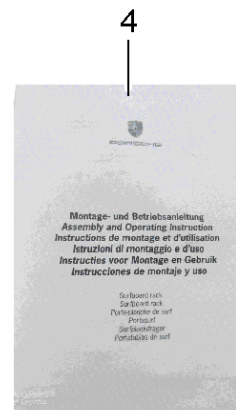
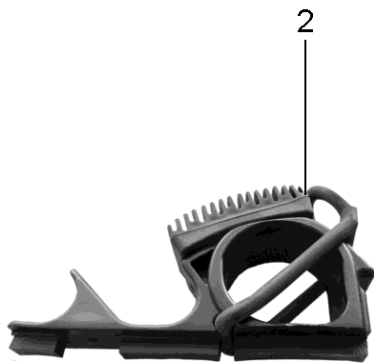
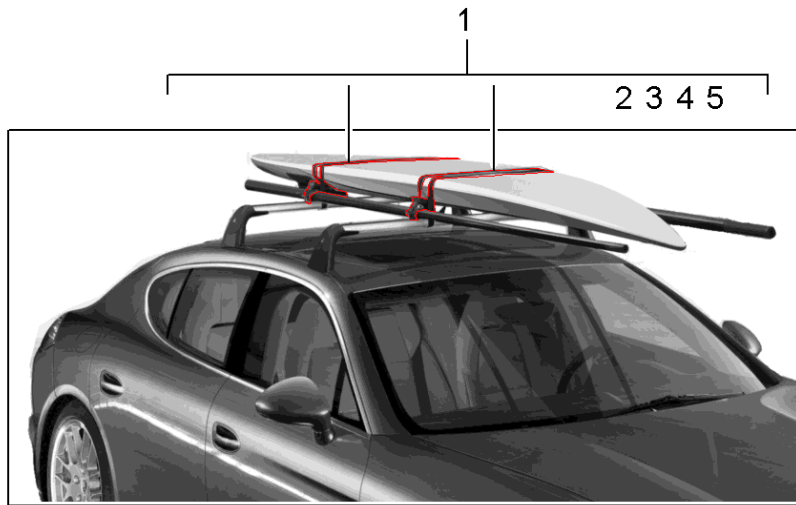

Model: TEQ 3 Model life 2010>>

Pos	Part Number	Description	Remark	Qty	Model
-		Surfboard support D - MJ 2010>> Not for: Loading aid			955044.00007
-		Technical information Porsche Cayenne Group 6 6692 (5/03) Attention			alle
1	955 044 000 07	Surfboard support Set		1	
2	955 044 000 31	Support Set 4-part		1	
3	955 044 000 32	tensioning strap SATZ	2-part	1	
4		Operating instructions		1	
5	955 044 000 52	repair set		1	
-		comprising:			
6		Hexagon socket head bolt		4	M6 x 16
7		castellated nut		4	M6 x 20 x 4
8		Washer		4	4 x 12 x 1
9		Socket wrench		1	

Model: TEQ 3

Model life 2010>>

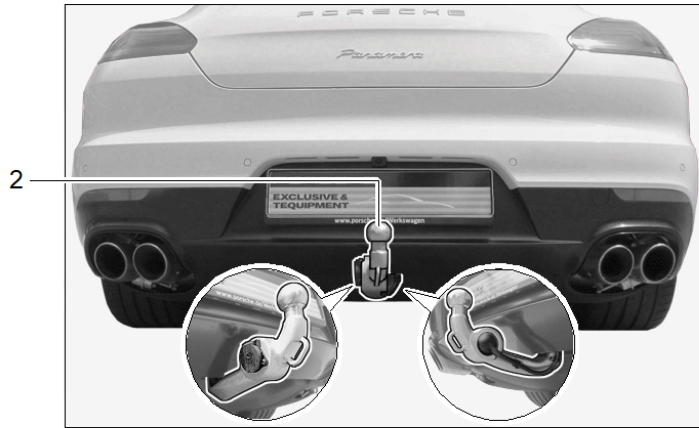

Model: TEQ 3 Model life 2010>>

Pos	Part Number	Description	Remark	Qty	Model
-		Tow hitch Electric D - MJ 2012>> Inst. & Conv. Instructions Panamera Group 6 6690 (6/12) Attention			OHNE/NOT FOR HYBRID ohne Hybrid
1	970 044 800 15	Tow hitch Electric D - MJ 2012>> - MJ 2013		1	PR:029,216 -"USA", -"CDN", -"AUS", -"CN."
(1)	970 044 800 16	Tow hitch Electric D - MJ 2012>> - MJ 2013		1	PR:216,350, 351 -"USA", -"CDN", -"AUS", -"CN."
-		Inst. & Conv. Instructions Panamera Group 6 6690 (29/13) Attention			ohne Hybrid
2	970 044 802 45	Tow hitch Electric D - MJ 2014>>		1	PR:029,216, 475 -"USA", -"CDN", -"AUS", -"CN."
(2)	970 044 802 46	Tow hitch Electric D - MJ 2014>>		1	PR:216,350, 351 -"USA", -"CDN", -"AUS", -"CN."
-		Inst. & Conv. Instructions Panamera Group 6 6690 (07/17) Attention			
3	971 044 870	Tow hitch Electric D - MJ 2017>>		1	PR:1D7,0E1, 0K0,-K8D -"USA", -"CDN", -"AUS", -"CN."

Model: TEQ 3

Model life 2010>>

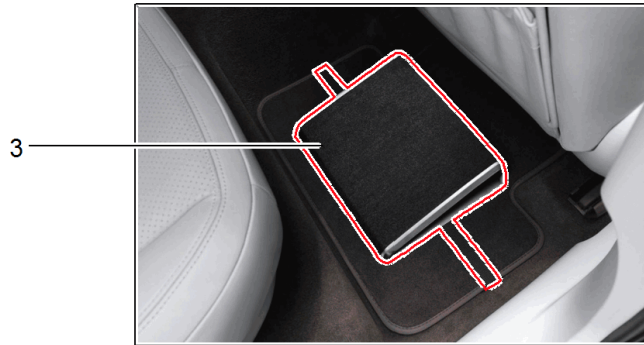
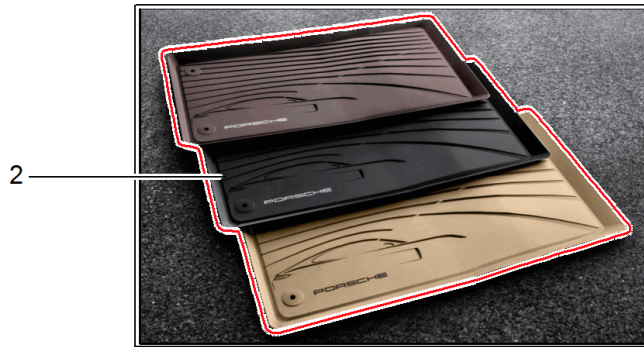

Model: TEQ 3 Model life 2010>>

Pos	Part Number	Description	Remark	Qty	Model
1	970 551 063 00	Floor mats Velour Rubber D - MJ 2010>> 1 set foot mats Velour	rear	1	/LL
		with:			
		Retaining clip Set D - MJ 2010>> - MJ 2010			
	970 551 063 00 DJ6	Platinum Grey			
	970 551 063 00 DK4	Black			
	970 551 063 00 DM5	Luxor beige			
	970 551 063 00 DP8	Espresso			
	970 551 063 00 DQ9	yachting blue			
	970 551 063 00 DS1	Cognac			
	970 551 063 00 DT2	Marsala Red			
(1)	970 551 063 02	1 set foot mats Velour	rear	1	/LL
		without:			
		Retaining clip Set D - MJ 2011>> - MJ 2016			
	970 551 063 02 DJ6	Platinum Grey			
	970 551 063 02 DK4	Black			
	970 551 063 02 DM5	Luxor beige			
	970 551 063 02 DP8	Espresso			
	970 551 063 02 DQ9	yachting blue			
	970 551 063 02 DSM	black/silver			
	970 551 063 02 DS1	Cognac			
	970 551 063 02 DT2	Marsala Red			
	970 551 063 02 DUD	Black/Luxor Beige			
	970 551 063 02 IVG	Black/Carmin Red			
	970 551 063 02 OJ1	agate grey			
	970 551 063 02 OP2	saddle brown			
(1)	970 551 063 05	1 set foot mats Velour	rear	1	/LL PR:0E2
		with:			
		Retaining clip Set D - MJ 2014>> - MJ 2016			
	970 551 063 05 DK4	Black			
	970 551 063 05 DM5	Luxor beige			
	970 551 063 05 DP8	Espresso			
	970 551 063 05 DS1	Cognac			
	970 551 063 05 DT2	Marsala Red			
	970 551 063 05 OJ1	agate grey			
	970 551 063 05 OP2	saddle brown			
(1)	970 551 063 01	1 set foot mats Velour	rear	1	/RL
		with:			
		Retaining clip Set D - MJ 2010>> - MJ 2010			
	970 551 063 01 DJ6	Platinum Grey			
	970 551 063 01 DK4	Black			
	970 551 063 01 DM5	Luxor beige			
	970 551 063 01 DP8	Espresso			
	970 551 063 01 DQ9	yachting blue			
	970 551 063 01 DS1	Cognac			
	970 551 063 01 DT2	Marsala Red			
(1)	970 551 063 03	1 set foot mats Velour	rear	1	/RL

Model: TEQ 3 Model life 2010>>

Pos	Part Number	Description	Remark	Qty	Model
		without:			
		Retaining clip			
		Set			
		D - MJ 2011>> - MJ 2016			
	970 551 063 03 DJ6	Platinum Grey			
	970 551 063 03 DK4	Black			
	970 551 063 03 DM5	Luxor beige			
	970 551 063 03 DP8	Espresso			
	970 551 063 03 DQ9	yachting blue			
	970 551 063 03 DSM	black/silver			
	970 551 063 03 DS1	Cognac			
	970 551 063 03 DT2	Marsala Red			
	970 551 063 03 DUD	Black/Luxor Beige			
	970 551 063 03 IVG	Black/Carmine Red			
	970 551 063 03 OJ1	agate grey			
	970 551 063 03 OP2	saddle brown			
1	971 864 435	1 set foot mats Velour	front	1	/LL PR:0E1
		with:			
		Retaining clip			
		D - MJ 2017>>			
	971 864 435 2D0	Marsala Red			
	971 864 435 3E0	Luxor beige			
	971 864 435 9M0	Black			
	971 864 435 BP1	saddle brown			
	971 864 435 OK2	agate grey			
	971 864 435 OK4	Truffle Brown			
	971 864 435 OW9	Cohiba Brown			
(1)	971 864 436	1 set foot mats Velour	front	1	/RL PR:0E1
		with:			
		Retaining clip			
		D - MJ 2017>>			
	971 864 436 2D0	Marsala Red			
	971 864 436 3E0	Luxor beige			
	971 864 436 9M0	Black			
	971 864 436 BP1	saddle brown			
	971 864 436 OK2	agate grey			
	971 864 436 OK4	Truffle Brown			
	971 864 436 OW9	Cohiba Brown			
(1)	971 864 435 A	1 set foot mats Velour	front and rear	1	/LL PR:0E2
		with:			
		Retaining clip			
		D - MJ 2017>>			
	971 864 435 A 2D0	Marsala Red			
	971 864 435 A 3E0	Luxor beige			
	971 864 435 A 9M0	Black			
	971 864 435 A BP1	saddle brown			
	971 864 435 A OK2	agate grey			
	971 864 435 A OK4	Truffle Brown			
	971 864 435 A OW9	Cohiba Brown			
(1)	971 864 436 A	1 set foot mats Velour	front and rear	1	/RL PR:0E2
		with:			
		Retaining clip			
		D - MJ 2017>>			
	971 864 436 A 2D0	Marsala Red			
	971 864 436 A 3E0	Luxor beige			
	971 864 436 A 9M0	Black			
	971 864 436 A BP1	saddle brown			
	971 864 436 A OK2	agate grey			
	971 864 436 A OK4	Truffle Brown			

Model: TEQ 3 Model life 2010>>

Pos	Part Number	Description	Remark	Qty	Model
2	971 864 436 A OW9 970 044 800 07	Cohiba Brown 1 set foot mats (rubber)	rear	1	/LL PR:0E1
		without: Retaining clip D - MJ 2010>> - MJ 2016			
(2)	970 044 800 10	1 set foot mats (rubber)	rear	1	/LL PR:0E2 -"CN."
		with: Retaining clip D - MJ 2014>> - MJ 2016			
(2)	970 044 800 11	1 set foot mats (rubber)	rear	1	/LL PR:0E2 "CN."
		with: Retaining clip D - MJ 2014>> - MJ 2016			
(2)	970 044 800 09	1 set foot mats (rubber)	rear	1	/RL -"CN."
		without: Retaining clip D - MJ 2010>> - MJ 2016			
(2)	971 044 800	1 set foot mats (rubber)	front	1	/LL PR:0E1
		with: Retaining clip D - MJ 2017>>			
	971 044 800 1E0	Black			
	971 044 800 3G0	Marsala Red			
	971 044 800 4H0	Luxor beige			
(2)	971 044 800 A	1 set foot mats (rubber)	front	1	/RL PR:0E1
		with: Retaining clip D - MJ 2017>>			
	971 044 800 A 1E0	Black			
	971 044 800 A 3G0	Marsala Red			
	971 044 800 A 4H0	Luxor beige			
(2)	971 044 800 B	Foot mat (rubber)	front and rear	1	/LL PR:0E2
		Executive with: Retaining clip Set D - MJ 2017>>			
	971 044 800 B 1E0	Black			
	971 044 800 B 3G0	Marsala Red			
	971 044 800 B 4H0	Luxor beige			
(2)	971 044 800 C	Foot mat (rubber)	front and rear	1	/RL PR:0E2
		Executive with: Retaining clip Set D - MJ 2017>>			
	971 044 800 C 1E0	Black			
	971 044 800 C 3G0	Marsala Red			
	971 044 800 C 4H0	Luxor beige			
3	970 044 802 80	Foot rest	rear	1	
	970 044 802 80 DK4	Black			
4	971 044 821	1 set foot mats Carbon 4-part D - MJ 2017>>		1	/LL PR:0E1 -"CN."

Model: TEQ 3 Model life 2010>>

Pos	Part Number	Description	Remark	Qty	Model
(4)	971 044 820	1 set foot mats Carbon 4-part D - MJ 2017>>		1	/RL PR:0E1

Model: TEQ 3

Model life 2010>>



Model: TEQ 3 Model life 2010>>

Pos	Part Number	Description	Remark	Qty	Model
		Sill trim strip	10-16		
		without:			
(1)	970 044 800 20	Lighting 1 set of sill strips Carbon	-16	1	Panamera
(1)	970 044 800 21	1 set of sill strips Carbon	-16	1	Panamera 4
(1)	970 044 800 22	1 set of sill strips Carbon	-16	1	Panamera S PR:-0E2
(1)	970 044 800 44	1 set of sill strips Carbon	-16	1	Panamera S Executive PR:0E2
(1)	970 044 800 23	1 set of sill strips Carbon	-16	1	Panamera 4S PR:-0E2
(1)	970 044 800 45	1 set of sill strips Carbon	-16	1	Panamera 4S PR:0E2
1	970 044 800 24	1 set of sill strips Carbon	-16	1	Panamera Turbo PR:-0E2
1	970 044 800 46	1 set of sill strips Carbon	-16	1	Panamera Turbo Executive PR:0E2
(1)	970 044 800 18	1 set of sill strips Carbon	-16	1	Panamera Executive PR:0E2
(1)	970 044 800 19	1 set of sill strips Carbon	-16	1	Panamera 4 Executive PR:0E2
-	970 044 800 37	1 set of sill strips mahagoni	-16	1	PR:-0E2
-	970 044 800 47	1 set of sill strips mahagoni	-16	1	Executive PR:0E2
(1)	970 044 800 38	1 set of sill strips Carbon	-16	1	Panamera GTS
(1)	970 044 800 39	1 set of sill strips Carbon	-16	1	Panamera Turbo S PR:-0E2
(1)	970 044 800 48	1 set of sill strips Carbon	-16	1	Panamera Turbo S PR:0E2

Model: TEQ 3

Model life 2010>>



1

Model: TEQ 3 Model life 2010>>

Pos	Part Number	Description	Remark	Qty	Model
		Sill trim strip			
		without:			
		Lighting			
		D - MJ 2017>>			
1	971 044 810	1 set of sill strips Carbon		1	Panamera PR:0E1
(1)	971 044 810 A	1 set of sill strips Carbon		1	Panamera 4 PR:0E1
(1)	971 044 810 C	1 set of sill strips Carbon		1	Panamera 4S PR:0E1
(1)	971 044 810 D	1 set of sill strips Carbon		1	Panamera Turbo PR:0E1
(1)	971 044 810 E	1 set of sill strips Carbon		1	Panamera Turbo S PR:0E1
(1)	971 044 811	1 set of sill strips Carbon		1	Panamera Executive PR:0E2
(1)	971 044 811 A	1 set of sill strips Carbon		1	Panamera 4 Executive PR:0E2
(1)	971 044 811 C	1 set of sill strips Carbon		1	Panamera 4S Executive PR:0E2
(1)	971 044 811 D	1 set of sill strips Carbon		1	Panamera Turbo Executive PR:0E2
(1)	971 044 811 E	1 set of sill strips Carbon		1	Panamera Turbo S Executive PR:0E2

Model: TEQ 3

Model life 2010>>



Model: TEQ 3 Model life 2010>>

Pos	Part Number	Description	Remark	Qty	Model
-		Sill trim strip with: Lighting Inst. & Conv. Instructions Panamera Group 6 6807 (26/09) 6807 (7/11) Attention	10-16		alle
(1)	970 044 800 25	1 set of sill strips aluminium	-11	1	Panamera
(1)	970 044 802 30	1 set of sill strips aluminium	12-16	1	Panamera PR:0E1
(1)	970 044 800 26	1 set of sill strips aluminium	-11	1	Panamera 4
(1)	970 044 802 31	1 set of sill strips aluminium	12-16	1	Panamera 4 PR:0E1
(1)	970 044 800 27	1 set of sill strips aluminium	-11	1	Panamera S
(1)	970 044 802 32	1 set of sill strips aluminium	12-16	1	Panamera S PR:0E1
(1)	970 044 802 35	1 set of sill strips aluminium green Lighting	-16	1	Panamera S PR:0E2
(1)	970 044 800 28	1 set of sill strips aluminium	-11	1	Panamera 4S
(1)	970 044 802 33	1 set of sill strips aluminium	12-16	1	Panamera 4S PR:0E1
(1)	970 044 802 53	1 set of sill strips aluminium	-16	1	Panamera 4S PR:0E2
1	970 044 800 29	1 set of sill strips aluminium	-11	1	Panamera Turbo
1	970 044 802 34	1 set of sill strips aluminium	12-16	1	Panamera Turbo PR:0E1
1	970 044 802 54	1 set of sill strips aluminium	-16	1	Panamera Turbo PR:0E2
(1)	970 044 800 40	1 set of sill strips aluminium	-16	1	Panamera GTS
(1)	970 044 800 41	1 set of sill strips aluminium	-16	1	Panamera Turbo S PR:0E1
(1)	970 044 802 55	1 set of sill strips aluminium	-16	1	Panamera Turbo S PR:0E2
(1)	970 044 802 56	1 set of sill strips aluminium	-16	1	Panamera Executive PR:0E2
(1)	970 044 802 57	Included electrical components 1 set of sill strips aluminium	-16	1	Panamera 4 Executive PR:0E2
-		Included electrical components Inst. & Conv. Instructions Panamera Group 6			alle

Model: TEQ 3 Model life 2010>>

Pos	Part Number	Description	Remark	Qty	Model
		6807 (30/09) 6807 (7/11) Attention			
(1)	970 044 800 30	1 set of sill strips Carbon	-11	1	Panamera
(1)	970 044 802 37	1 set of sill strips Carbon	12-16	1	Panamera PR:0E1
(1)	970 044 800 31	1 set of sill strips Carbon	-11	1	Panamera 4
(1)	970 044 802 38	1 set of sill strips Carbon	12-16	1	Panamera 4 PR:0E1
(1)	970 044 800 32	1 set of sill strips Carbon	-11	1	Panamera S
(1)	970 044 802 39	1 set of sill strips Carbon	12-16	1	Panamera S PR:0E1
(1)	970 044 802 42	1 set of sill strips Carbon	-16	1	Panamera S Hybrid PR:0E1
		green Lighting			
(1)	970 044 802 59	1 set of sill strips Carbon	-16	1	Panamera S PR:0E2
(1)	970 044 800 33	1 set of sill strips Carbon	-11	1	Panamera 4S
(1)	970 044 802 40	1 set of sill strips Carbon	12-16	1	Panamera 4S PR:0E1
(1)	970 044 802 60	1 set of sill strips Carbon	-16	1	Panamera 4S PR:0E2
(1)	970 044 800 34	1 set of sill strips Carbon	-11	1	Panamera Turbo
(1)	970 044 802 41	1 set of sill strips Carbon	12-16	1	Panamera Turbo PR:0E1
(1)	970 044 802 61	1 set of sill strips Carbon	-16	1	Panamera Turbo PR:0E2
(1)	970 044 800 42	1 set of sill strips Carbon	-16	1	Panamera GTS
(1)	970 044 800 43	1 set of sill strips Carbon	-16	1	Panamera Turbo S PR:0E1
(1)	970 044 802 62	1 set of sill strips Carbon	-16	1	Panamera Turbo S PR:0E2
(1)	970 044 802 63	1 set of sill strips Carbon	-16	1	Panamera Executive PR:0E2
		Included electrical components			
(1)	970 044 802 64	1 set of sill strips Carbon	-16	1	Panamera 4 Executive PR:0E2
		Included electrical components			

Model: TEQ 3

Model life 2010>>



1

Model: TEQ 3 Model life 2010>>

Pos	Part Number	Description	Remark	Qty	Model
1	970 044 800 02	Carpet Luggage compartment mat Carpet Luggage compartment mat	velours 10-16 velours	1	V8 / Turbo V6
	970 044 800 02 DJ6	Platinum Grey			
	970 044 800 02 DK4	Black			
	970 044 800 02 DM5	Luxor beige			
	970 044 800 02 DP8	Espresso			
	970 044 800 02 DQ9	yachting blue			
	970 044 800 02 DS1	Cognac			
	970 044 800 02 DT2	Marsala Red			
	970 044 800 02 OJ1	agate grey			
	970 044 800 02 OP2	saddle brown			
(1)	970 044 800 03	Carpet Luggage compartment mat	12-16 velours	1	Hybrid PR:-680
	970 044 800 03 DJ6	Platinum Grey			
	970 044 800 03 DK4	Black			
	970 044 800 03 DM5	Luxor beige			
	970 044 800 03 DP8	Espresso			
	970 044 800 03 DQ9	yachting blue			
	970 044 800 03 DS1	Cognac			
	970 044 800 03 DT2	Marsala Red			
	970 044 800 03 OJ1	agate grey			
	970 044 800 03 OP2	saddle brown			
(1)	970 044 800 04	Carpet Luggage compartment mat	12-16 velours	1	Hybrid PR:680
	970 044 800 04 DJ6	Platinum Grey			
	970 044 800 04 DK4	Black			
	970 044 800 04 DM5	Luxor beige			
	970 044 800 04 DP8	Espresso			
	970 044 800 04 DQ9	yachting blue			
	970 044 800 04 DS1	Cognac			
	970 044 800 04 DT2	Marsala Red			
	970 044 800 04 OJ1	agate grey			
	970 044 800 04 OP2	saddle brown			
(1)	971 044 803	Carpet Luggage compartment mat	17- velours	1	PR:3GA OHNE/NOT FOR SportTurismo
	971 044 803 2D0	Marsala Red			
	971 044 803 3E0	Luxor beige			
	971 044 803 9M0	Black			
	971 044 803 BP1	saddle brown			
	971 044 803 OK2	agate grey			
	971 044 803 OK4	Truffle Brown			
	971 044 803 OW9	Cohiba Brown			
(1)	971 044 803 A	Carpet Luggage compartment mat	18- velours	1	PR:3GA SportTurismo
	971 044 803 A 2D0	Marsala Red			
	971 044 803 A 3E0	Luxor beige			
	971 044 803 A 9M0	Black			
	971 044 803 A BP1	saddle brown			
	971 044 803 A OK2	agate grey			
	971 044 803 A OK4	Truffle Brown			
	971 044 803 A OW9	Cohiba Brown			

Model: TEQ 3

Model life 2010>>



Model: TEQ 3 Model life 2010>>

Pos	Part Number	Description	Remark	Qty	Model
1	970 044 000 17	Luggage compartment liner Luggage net Luggage compartment liner for cars without Cooling bag Refrigerator	10- 17-	1	OHNE/NOT FOR HYBRID 95504490230 97004400000
(1)	971 044 805	D >> - MJ 2016 Luggage compartment liner D - MJ 2017>>		1	
(1)	971 044 805 A	Luggage compartment liner D - MJ 2018>>		1	SportTurismo
2	970 044 000 20	Luggage net Luggage compartment for cars without Cooling bag Refrigerator		1	95504490230 97004400000

Model: TEQ 3

Model life 2010>>

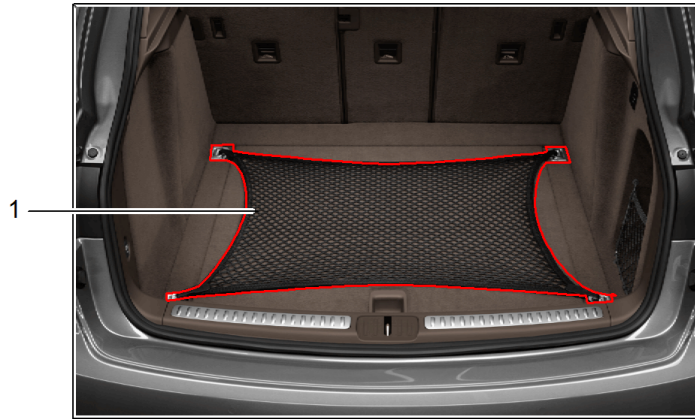

Model: TEQ 3

Model life 2010>>

Pos	Part Number	Description	Remark	Qty	Model
1	971 044 010	Luggage net D - MJ 2017>> Luggage net Not for: Luggage compartment liner		1	

Model: TEQ 3

Model life 2010>>

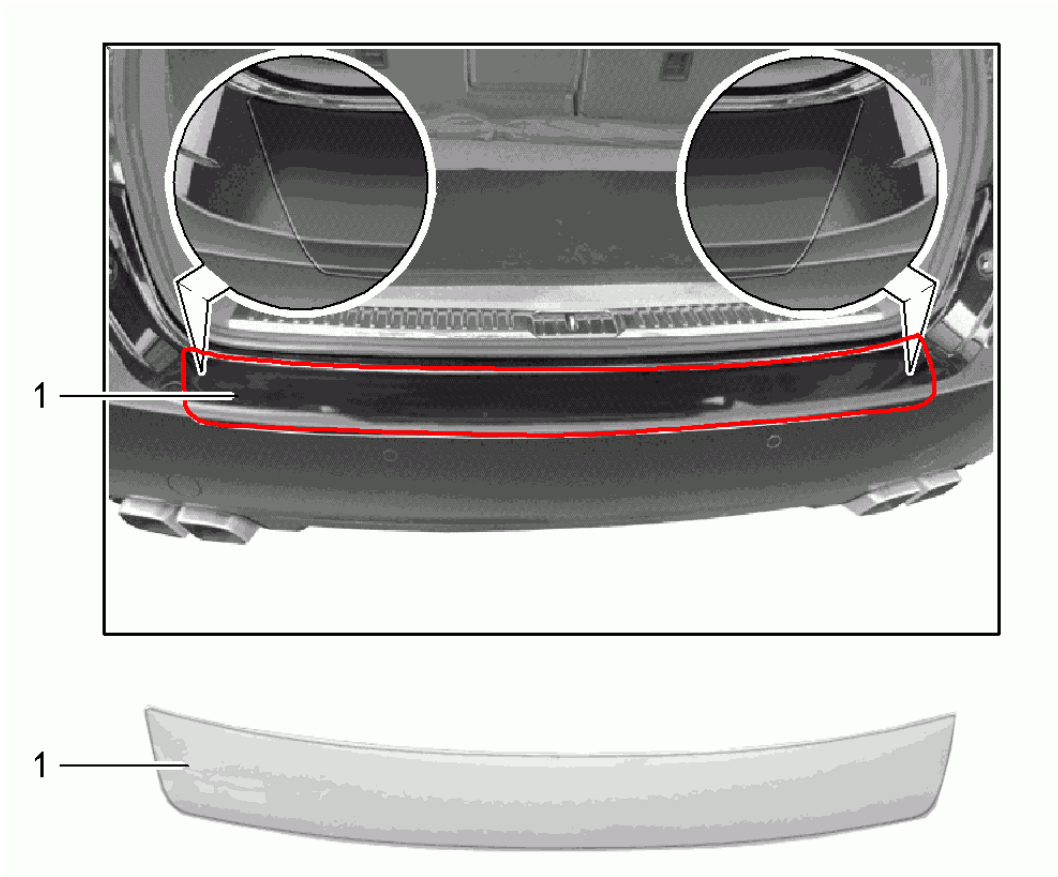

Model: TEQ 3

Model life 2010>>

Pos	Part Number	Description	Remark	Qty	Model
1	971 044 808	Load edge protection Protective film Protective film for bumper	18- PR: K8D	1	

Model: TEQ 3

Model life 2010>>



1



2

1



3



4



7



5



6



8

Model: TEQ 3 Model life 2010>>

Pos	Part Number	Description	Remark	Qty	Model
-		child seat D - MJ 2010>> Operating instructions Attention /F = Front = Vorn only in conj. with: /R = Rear = Hinten Use			PR:899
(1)	955 044 802 86	child seat BABY SEAT ISOFIX G0+ 0-13 KG Included Main support	/F /R	1	- "AUS" Panamera alle
1	955 044 802 94	No longer use the part here child seat BABY SEAT G0+ 0-13 KG	/F /R	1	95504480295 - "AUS" Panamera alle
-		use if required:			
2	955 044 802 95	Main support for child seat	/F /R	1	Isofix 95504480294
3	955 044 802 92	child seat Junior Seat Isofix G1 with:	/F /R	1	- "AUS" - "AUS" Panamera alle
5	955 044 802 90	Support 9-18 KG child seat Junior Plus Seat G2+G3 15-36 KG	/F /R	1	- "AUS" Panamera alle
6	955 044 802 96	child seat Junior Plus Seat G2+G3 Isofit 15-36 KG	/F /R	1	- "AUS" Panamera alle
-		Only for replacement Order			
7	955 044 802 93	Guide child seat Rail Set		1	
8	958 044 801 80	Child seat underlay with: Pockets	front	1	

Model: TEQ 3

Model life 2010>>



Model: TEQ 3

Model life 2010>>

Pos	Part Number	Description	Remark	Qty	Model
-		Beverages Bracket D - MJ 2010>> workshop manual Panamera Group 6 6830 beachten			alle
1	970 044 800 05	Repair set for drinks holder Galvano silver	lhd	1	PR:098,-585, L0L
(1)	970 044 800 06	Repair set for drinks holder Galvano silver	rhd	1	PR:099,-585, L0R

Model: TEQ 3

Model life 2010>>

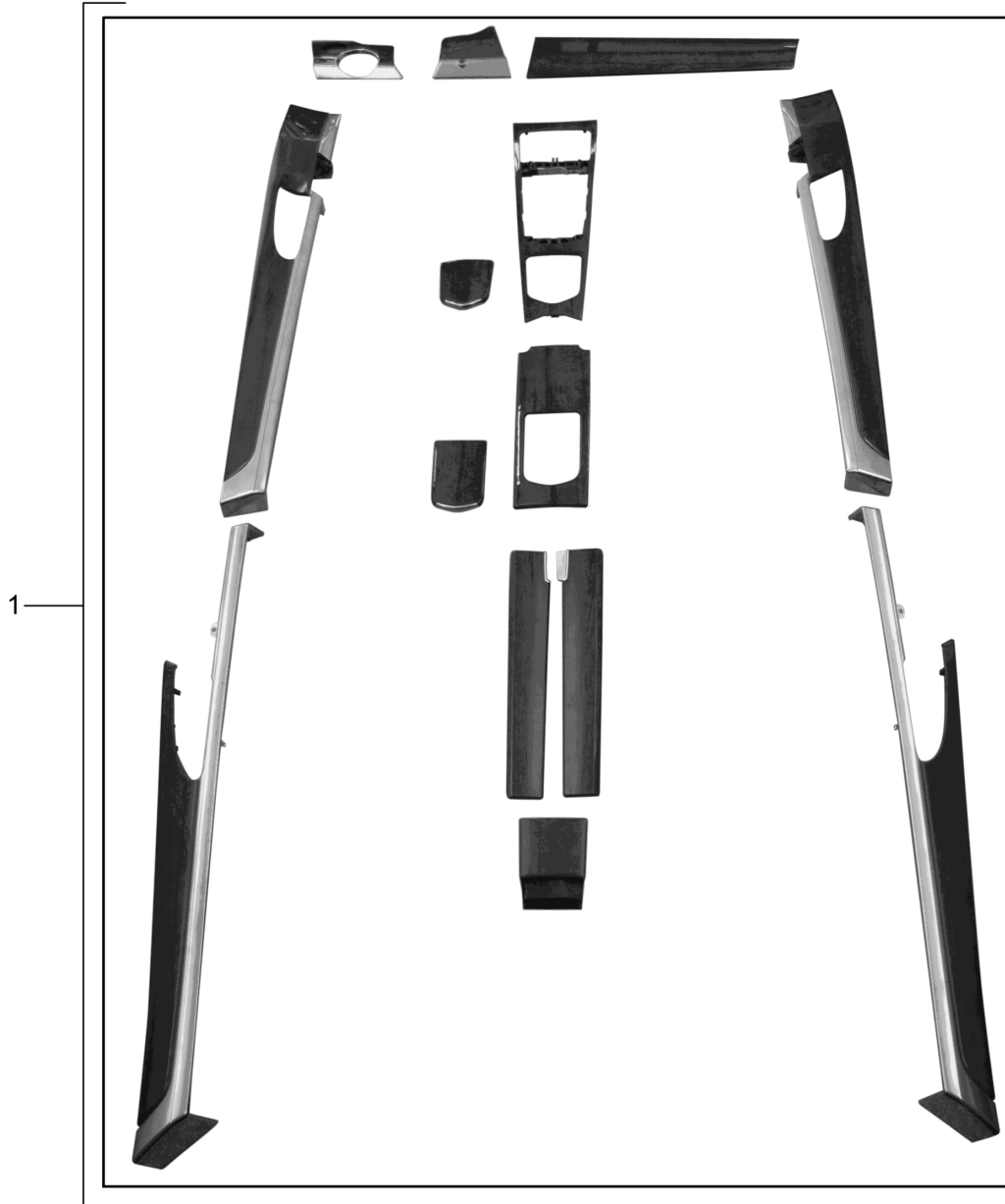

Model: TEQ 3 Model life 2010>>

Pos	Part Number	Description	Remark	Qty	Model
-		Passenger compartment Package Walnut, high-gloss D - MJ 2010>> - MJ 2016 Package comprising: Trim Centre console door panel Instrument panel trim			
(1)	970 044 800 78	1 set of trims for dash board, central console and door trim panels	rhd	1	PR:538, L0R,-838
(1)	970 044 800 80	Discontinued part 1 set of trims for dash board, central console and door trim panels	rhd	1	PR:537,538, L0R,-838
-		Discontinued part Appendix Package comprising: steering wheel selector lever		1 1	PR:XYA,250
-	970 044 800 82	Interior equipment Appendix Package No longer use the part here		1	PR:-639, -640,250
	970 044 800 82 DLC	Highly polished walnut root/ black			
	970 044 800 82 6U7	Discontinued part Highly polished walnut root/ yachting blue			
	970 044 800 82 7A0	Discontinued part Highly polished walnut root/ platinum grey			
	970 044 800 82 8C0	Discontinued part Highly polished walnut root/ espresso			
	970 044 800 82 9EF	Discontinued part Highly polished walnut root/ cognac			
-	970 044 800 83	Discontinued part Interior equipment Appendix Package D - MJ 2011>> No longer use the part here		1	PR:639,640, 250
	970 044 800 83 DLC	Highly polished walnut root/ black			
	970 044 800 83 7A0	Discontinued part Highly polished walnut root/ platinum grey Discontinued part			

Model: TEQ 3

Model life 2010>>

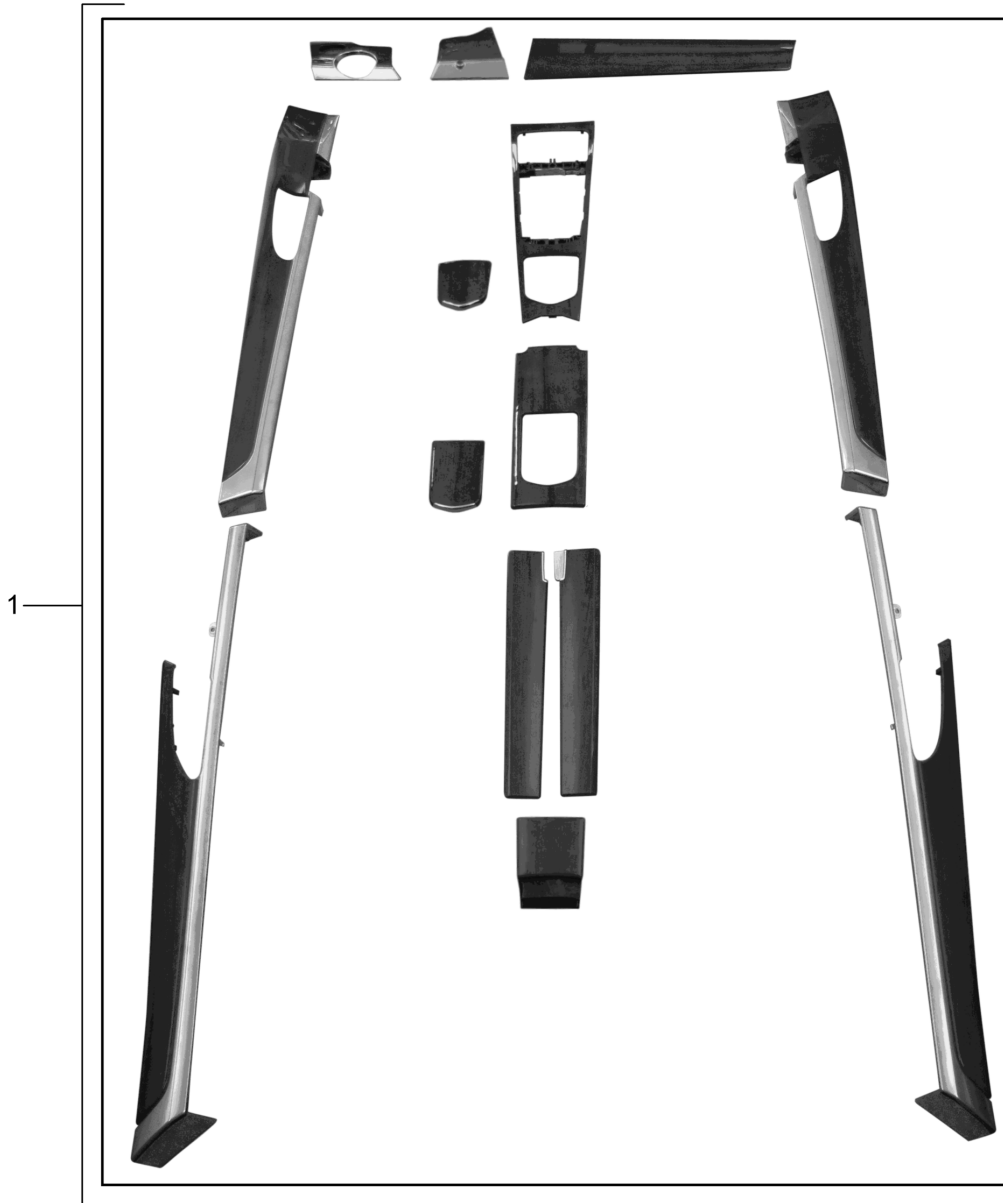

Model: TEQ 3 Model life 2010>>

Pos	Part Number	Description	Remark	Qty	Model
-		Passenger compartment Package Tineo D - MJ 2010>> - MJ 2016 Package comprising: Trim Centre console door panel Instrument panel trim			
(1)	970 044 800 85	1 set of trims for dash board, central console and door trim panels	lhd	1	PR:-537, -538,L0L, -838
(1)	970 044 800 86	1 set of trims for dash board, central console and door trim panels	lhd	1	PR:-537, -538,L0L,838
(1)	970 044 800 87	1 set of trims for dash board, central console and door trim panels	lhd	1	PR:537 L0L,-838
(1)	970 044 800 88	1 set of trims for dash board, central console and door trim panels	lhd	1	PR:537 L0L,838
1	970 044 800 89	1 set of trims for dash board, central console and door trim panels	lhd	1	PR:537,538, L0L,-838
(1)	970 044 800 90	1 set of trims for dash board, central console and door trim panels	lhd	1	PR:537,538, L0L,838
(1)	970 044 800 91	1 set of trims for dash board, central console and door trim panels	rhd	1	PR:-537, -538,L0R, -838
(1)	970 044 800 92	1 set of trims for dash board, central console and door trim panels	rhd	1	PR:-537, -538,L0R,838
(1)	970 044 800 93	1 set of trims for dash board, central console and door trim panels	rhd	1	PR:538, L0R,-838
(1)	970 044 800 94	1 set of trims for dash board, central console and door trim panels	rhd	1	PR:538, L0R,838
(1)	970 044 800 95	1 set of trims for dash board, central console and door trim panels	rhd	1	PR:537,538, L0R,-838
(1)	970 044 800 96	1 set of trims for dash board, central console and door trim panels	rhd	1	PR:537,538, L0R,838
-		Appendix Package comprising: steering wheel selector lever		1 1	PR:XYA,250
-	970 044 800 97	Interior equipment Appendix Package		1	PR:-639, -640,250
	970 044 800 97 DLC	Tineo/black			
	970 044 800 97 6U7	Tineo/yachting blue			
	970 044 800 97 7A0	Tineo/platinum grey			
	970 044 800 97 8C0	Tineo/espresso			
	970 044 800 97 9EF	Tineo/cognac			
	970 044 800 97 9H6	Tineo/luxor beige			
	970 044 800 97 8M8	Tineo/marsala red			
		D - MJ 2011>>			
	970 044 800 97 PL1	Tineo/agate grey			

Model: TEQ 3

Model life 2010>>

Pos	Part Number	Description	Remark	Qty	Model
-	970 044 800 98	Interior equipment Appendix Package D - MJ 2011>>		1	PR:639,640, 250
	970 044 800 98 DLC	Tineo/black			
	970 044 800 98 6U7	Tineo/yachting blue			
	970 044 800 98 7A0	Tineo/platinum grey			
	970 044 800 98 8C0	Tineo/espresso			
	970 044 800 98 9EF	Tineo/cognac			
	970 044 800 98 9H6	Tineo/luxor beige			
	970 044 800 98 8M8	Tineo/marsala red			
	970 044 800 98 PL1	Tineo/agate grey			

Model: TEQ 3

Model life 2010>>

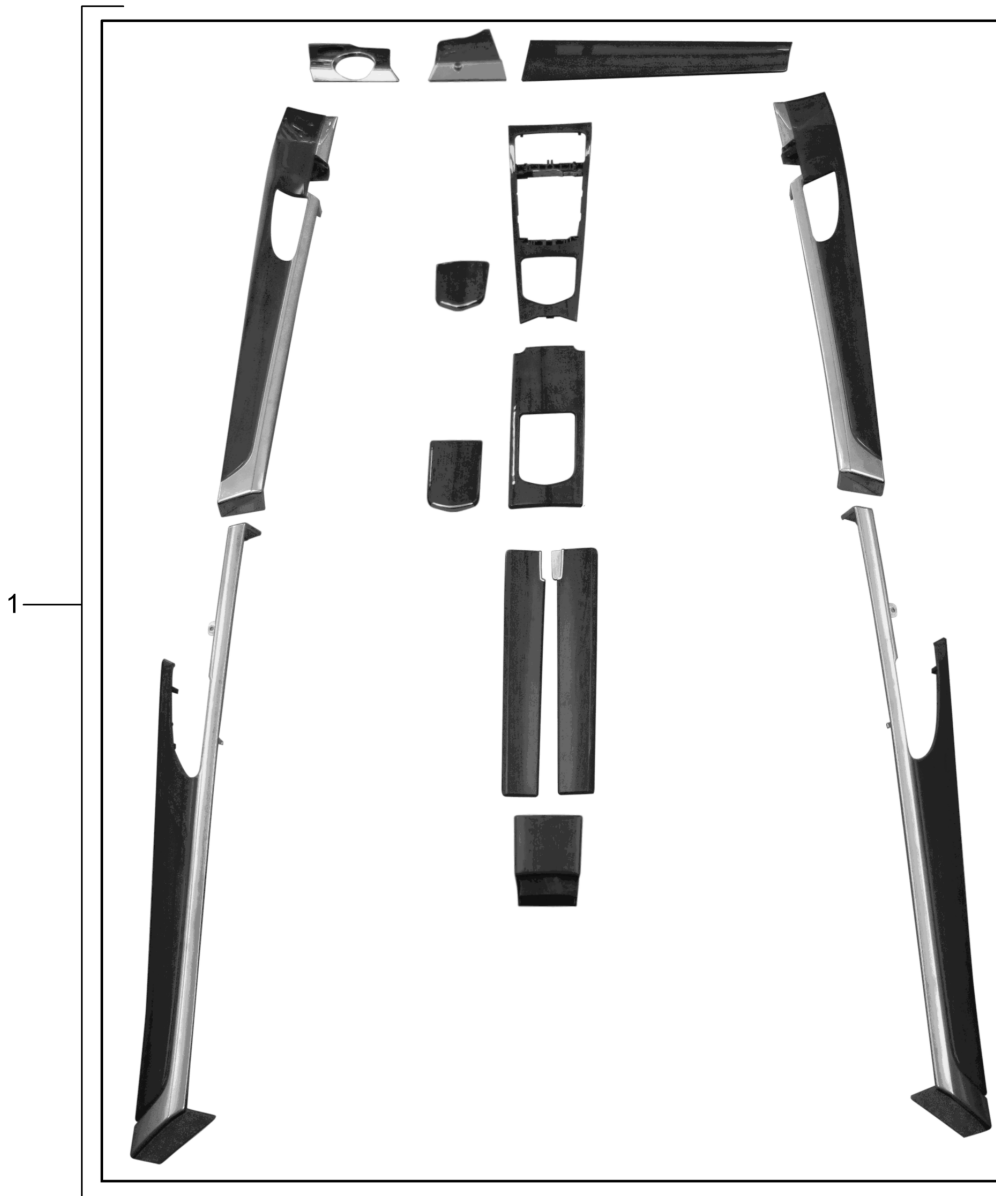

Model: TEQ 3 Model life 2010>>

Pos	Part Number	Description	Remark	Qty	Model
-		Passenger compartment Package Anthracite Birch D - MJ 2010>> - MJ 2016 Package comprising: Trim Centre console door panel Instrument panel trim			
(1)	970 044 801 00	1 set of trims for dash board, central console and door trim panels	lhd	1	PR:-537, -538,L0L, -838
(1)	970 044 801 01	1 set of trims for dash board, central console and door trim panels	lhd	1	PR:-537, -538,L0L,838
(1)	970 044 801 02	1 set of trims for dash board, central console and door trim panels	lhd	1	PR:537 L0L,-838
(1)	970 044 801 03	1 set of trims for dash board, central console and door trim panels	lhd	1	PR:537 L0L,838
1	970 044 801 04	1 set of trims for dash board, central console and door trim panels	lhd	1	PR:537,538, L0L,-838
(1)	970 044 801 05	1 set of trims for dash board, central console and door trim panels	lhd	1	PR:537,538, L0L,838
(1)	970 044 801 06	1 set of trims for dash board, central console and door trim panels	rhd	1	PR:-537, -538,L0R, -838
(1)	970 044 801 07	1 set of trims for dash board, central console and door trim panels	rhd	1	PR:-537, -538,L0R,838
(1)	970 044 801 08	1 set of trims for dash board, central console and door trim panels	rhd	1	PR:538, L0R,-838
(1)	970 044 801 09	1 set of trims for dash board, central console and door trim panels	rhd	1	PR:538, L0R,838
(1)	970 044 801 10	1 set of trims for dash board, central console and door trim panels	rhd	1	PR:537,538, L0R,-838
(1)	970 044 801 11	1 set of trims for dash board, central console and door trim panels	rhd	1	PR:537,538, L0R,838
-		Appendix Package comprising: steering wheel selector lever		1 1	PR:XYA,250
-	970 044 801 12	Interior equipment Appendix Package		1	PR:-639, -640,250
	970 044 801 12 DLC	Birch anthracite/black			
	970 044 801 12 6U7	Birch anthracite/yachting blue			
	970 044 801 12 7A0	Birch anthracite/platinum grey			
	970 044 801 12 8C0	Birch anthracite/espresso			
	970 044 801 12 9EF	Birch anthracite/cognac			
	970 044 801 12 9H6	Birch anthracite/luxor beige			
	970 044 801 12 8M8	Birch anthracite/marsala red			
		D - MJ 2011>>			
	970 044 801 12 PL1	Birch anthracite/agate grey			

Model: TEQ 3

Model life 2010>>

Pos	Part Number	Description	Remark	Qty	Model
-	970 044 801 13	Interior equipment Appendix Package D - MJ 2011>>		1	PR:639,640, 250
	970 044 801 13 DLC	Birch anthracite/black			
	970 044 801 13 6U7	Birch anthracite/yachting blue			
	970 044 801 13 7A0	Birch anthracite/platinum grey			
	970 044 801 13 8C0	Birch anthracite/espresso			
	970 044 801 13 9EF	Birch anthracite/cognac			
	970 044 801 13 9H6	Birch anthracite/luxor beige			
	970 044 801 13 8M8	Birch anthracite/marsala red			
	970 044 801 13 PL1	Birch anthracite/agate grey			

Model: TEQ 3

Model life 2010>>

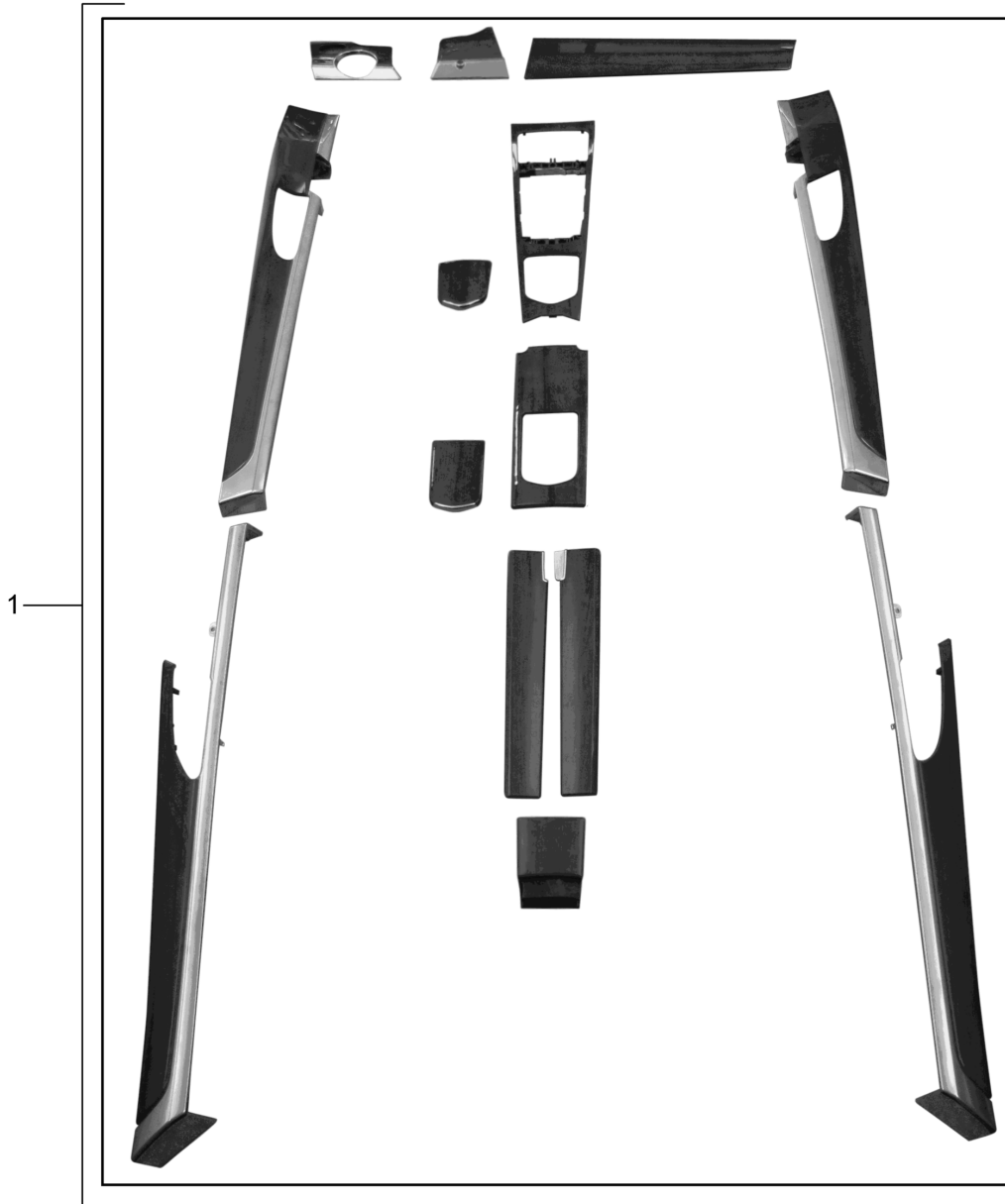

Model: TEQ 3 Model life 2010>>

Pos	Part Number	Description	Remark	Qty	Model
-		Passenger compartment Package Natural Olive D - MJ 2010>> - MJ 2016 Package comprising: Trim Centre console door panel Instrument panel trim			
(1)	970 044 801 15	1 set of trims for dash board, central console and door trim panels	lhd	1	PR:-537, -538,L0L, -838
(1)	970 044 801 16	1 set of trims for dash board, central console and door trim panels	lhd	1	PR:-537, -538,L0L,838
(1)	970 044 801 17	1 set of trims for dash board, central console and door trim panels	lhd	1	PR:537 L0L,-838
(1)	970 044 801 18	1 set of trims for dash board, central console and door trim panels	lhd	1	PR:537 L0L,838
1	970 044 801 19	1 set of trims for dash board, central console and door trim panels	lhd	1	PR:537,538, L0L,-838
(1)	970 044 801 20	1 set of trims for dash board, central console and door trim panels	lhd	1	PR:537,538, L0L,838
(1)	970 044 801 21	1 set of trims for dash board, central console and door trim panels	rhd	1	PR:-537, -538,L0R, -838
(1)	970 044 801 22	1 set of trims for dash board, central console and door trim panels	rhd	1	PR:-537, -538,L0R,838
(1)	970 044 801 23	1 set of trims for dash board, central console and door trim panels	rhd	1	PR:538, L0R,-838
(1)	970 044 801 24	1 set of trims for dash board, central console and door trim panels	rhd	1	PR:538, L0R,838
(1)	970 044 801 25	1 set of trims for dash board, central console and door trim panels	rhd	1	PR:537,538, L0R,-838
(1)	970 044 801 26	1 set of trims for dash board, central console and door trim panels	rhd	1	PR:537,538, L0R,838

Model: TEQ 3

Model life 2010>>

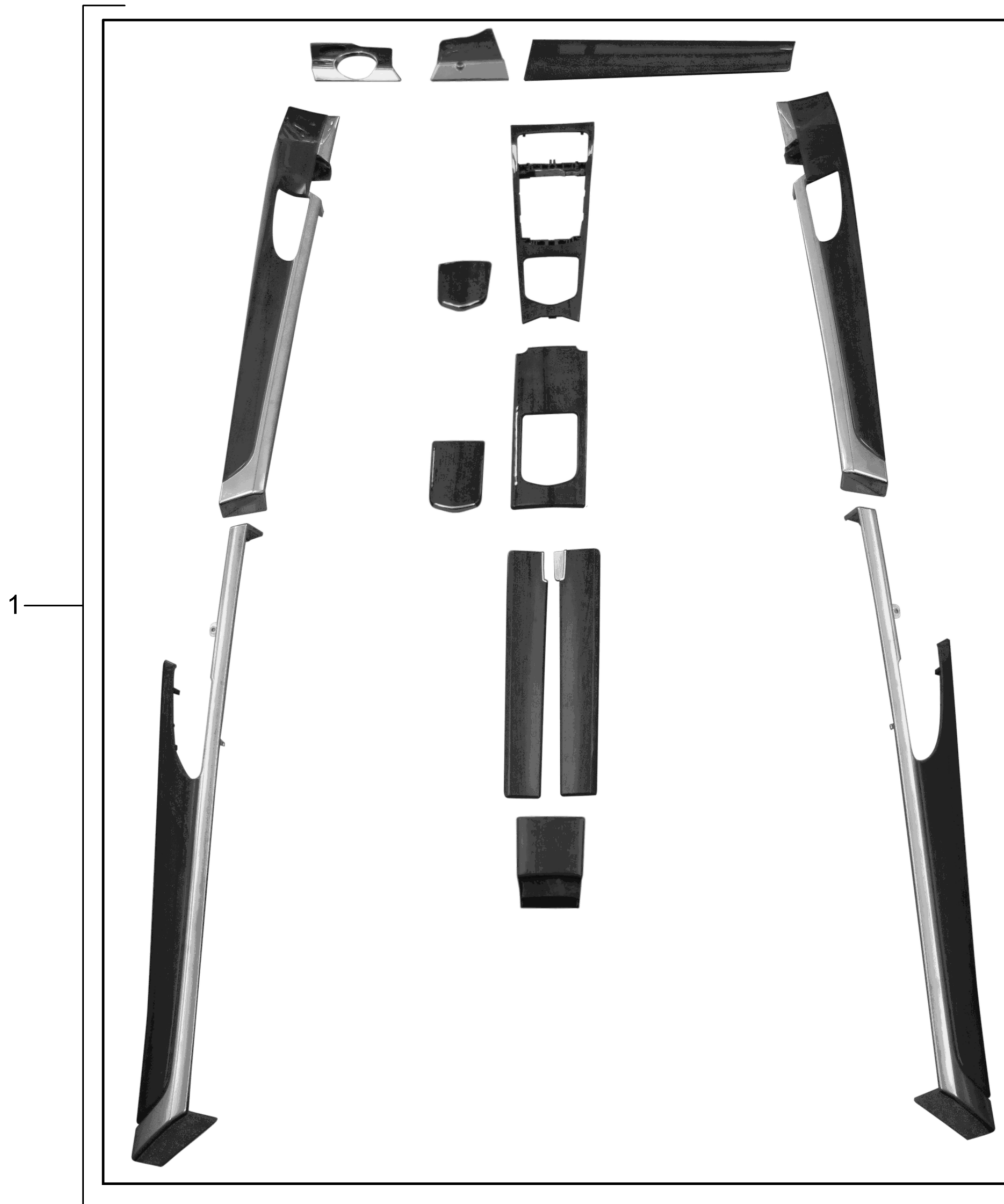

Model: TEQ 3 Model life 2010>>

Pos	Part Number	Description	Remark	Qty	Model
-		Passenger compartment Package Mahogany Yachting D - MJ 2010>> - MJ 2016 Package comprising: Trim Centre console door panel Instrument panel trim			
(1)	970 044 801 30	1 set of trims for dash board, central console and door trim panels	lhd	1	PR:-537, -538,L0L, -838
(1)	970 044 801 31	1 set of trims for dash board, central console and door trim panels	lhd	1	PR:-537, -538,L0L,838
(1)	970 044 801 32	1 set of trims for dash board, central console and door trim panels	lhd	1	PR:537 L0L,-838
(1)	970 044 801 33	1 set of trims for dash board, central console and door trim panels	lhd	1	PR:537 L0L,838
1	970 044 801 34	1 set of trims for dash board, central console and door trim panels	lhd	1	PR:537,538, L0L,-838
(1)	970 044 801 35	1 set of trims for dash board, central console and door trim panels	lhd	1	PR:0E1,537, 538,L0L,838
(1)	970 044 801 44	1 set of trims for dash board, central console and door trim panels	lhd	1	PR:0E2,537, 538,L0L,838
(1)	970 044 801 36	1 set of trims for dash board, central console and door trim panels	rhd	1	PR:-537, -538,L0R, -838
(1)	970 044 801 37	1 set of trims for dash board, central console and door trim panels	rhd	1	PR:-537, -538,L0R,838
(1)	970 044 801 38	1 set of trims for dash board, central console and door trim panels	rhd	1	PR:538, L0R,-838
(1)	970 044 801 39	1 set of trims for dash board, central console and door trim panels	rhd	1	PR:538, L0R,838
(1)	970 044 801 40	1 set of trims for dash board, central console and door trim panels	rhd	1	PR:537,538, L0R,-838
(1)	970 044 801 41	1 set of trims for dash board, central console and door trim panels	rhd	1	PR:537,538, L0R,838
-		Appendix Package comprising: steering wheel selector lever		1 1	PR:XYA,250
-	970 044 801 42	Interior equipment Appendix Package		1	PR:-639, -640,250
	970 044 801 42 DLC	Yachting mahogany/black			
	970 044 801 42 6U7	Yachting mahogany/yacht. blue			
	970 044 801 42 7A0	Yachting mahogany/plat. grey			
	970 044 801 42 8C0	Yachting mahogany/espresso			
	970 044 801 42 9EF	Yachting mahogany/cognac			
	970 044 801 42 9H6	Yachting mahogany/luxor beige			

Model: TEQ 3

Model life 2010>>

Pos	Part Number	Description	Remark	Qty	Model
-	970 044 801 42 8M8 970 044 801 42 PL1 970 044 801 43	Yachting mahogany/marsala red D - MJ 2011>> Yachting mahogany/agate grey Interior equipment Appendix Package D - MJ 2011>>		1	PR:639,640, 250
	970 044 801 43 DLC 970 044 801 43 6U7 970 044 801 43 7A0 970 044 801 43 8C0 970 044 801 43 9EF 970 044 801 43 9H6 970 044 801 43 8M8 970 044 801 43 PL1	Yachting mahogany/black Yachting mahogany/yacht. blue Yachting mahogany/plat. grey Yachting mahogany/espresso Yachting mahogany/cognac Yachting mahogany/luxor beige Yachting mahogany/marsala red Yachting mahogany/agate grey			

Model: TEQ 3

Model life 2010>>

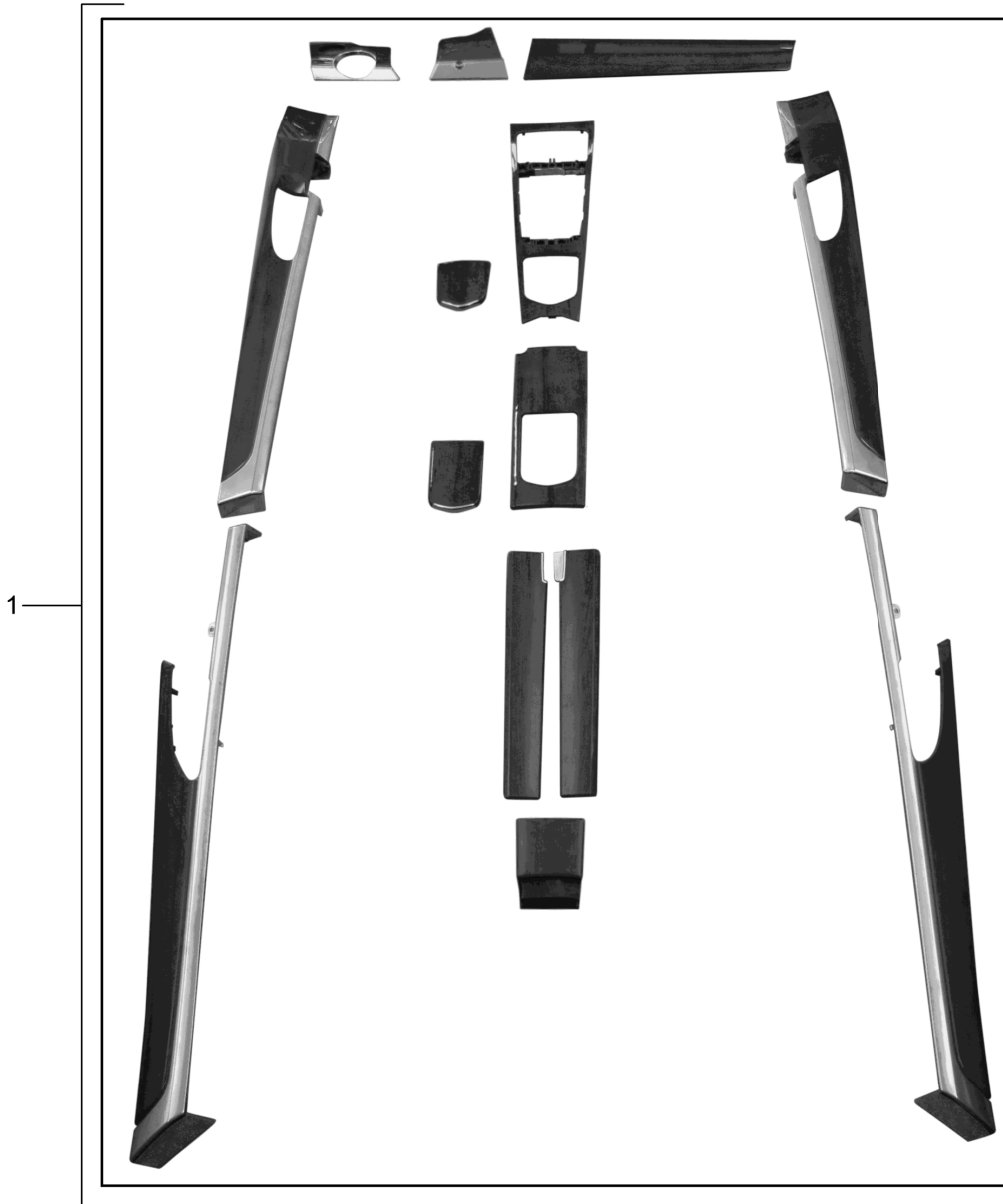

Model: TEQ 3 Model life 2010>>

Pos	Part Number	Description	Remark	Qty	Model
-		Passenger compartment Package aluminium D - MJ 2010>> - MJ 2016 Package comprising: Trim Centre console door panel Instrument panel trim			
(1)	970 044 801 45	1 set of trims for dash board, central console and door trim panels	lhd	1	PR:-537, -538,L0L, -838
(1)	970 044 801 46	1 set of trims for dash board, central console and door trim panels	lhd	1	PR:-537, -538,L0L,838
(1)	970 044 801 47	1 set of trims for dash board, central console and door trim panels	lhd	1	PR:537 L0L,-838
(1)	970 044 801 48	1 set of trims for dash board, central console and door trim panels	lhd	1	PR:537 L0L,838
1	970 044 801 49	1 set of trims for dash board, central console and door trim panels	lhd	1	PR:537,538, L0L,-838
(1)	970 044 801 50	1 set of trims for dash board, central console and door trim panels	lhd	1	PR:537,538, L0L,838
(1)	970 044 801 51	1 set of trims for dash board, central console and door trim panels	rhd	1	PR:-537, -538,L0R, -838
(1)	970 044 801 52	1 set of trims for dash board, central console and door trim panels	rhd	1	PR:-537, -538,L0R,838
(1)	970 044 801 53	1 set of trims for dash board, central console and door trim panels	rhd	1	PR:538, L0R,-838
(1)	970 044 801 54	1 set of trims for dash board, central console and door trim panels	rhd	1	PR:538, L0R,838
(1)	970 044 801 55	1 set of trims for dash board, central console and door trim panels	rhd	1	PR:537,538, L0R,-838
(1)	970 044 801 56	1 set of trims for dash board, central console and door trim panels	rhd	1	PR:537,538, L0R,838

Model: TEQ 3

Model life 2010>>

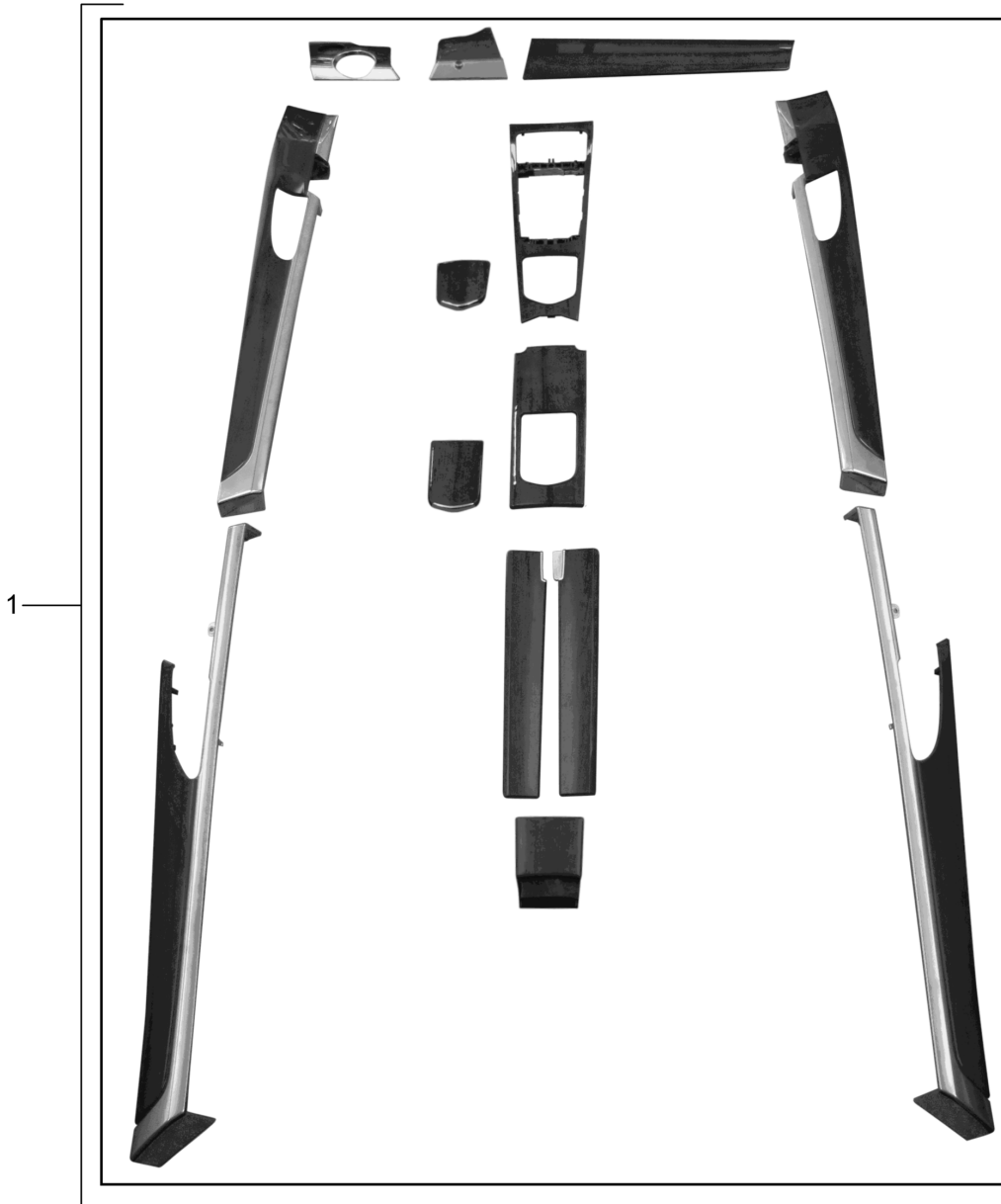

Model: TEQ 3 Model life 2010>>

Pos	Part Number	Description	Remark	Qty	Model
-		Passenger compartment Package Carbon D - MJ 2010>> - MJ 2016 Package comprising: Trim Centre console door panel Instrument panel trim			
(1)	970 044 801 60	1 set of trims for dash board, central console and door trim panels	lhd	1	PR:-537, -538,L0L, -838
(1)	970 044 801 61	1 set of trims for dash board, central console and door trim panels	lhd	1	PR:-537, -538,L0L,838
(1)	970 044 801 62	1 set of trims for dash board, central console and door trim panels	lhd	1	PR:537, L0L,-838
(1)	970 044 801 63	1 set of trims for dash board, central console and door trim panels	lhd	1	PR:537, L0L,838
1	970 044 801 64	1 set of trims for dash board, central console and door trim panels	lhd	1	PR:537,538, L0L,-838
(1)	970 044 801 65	1 set of trims for dash board, central console and door trim panels	lhd	1	PR:0E1,537, 538,L0L,838
(1)	970 044 801 74	1 set of trims for dash board, central console and door trim panels	lhd	1	PR:0E2,537, 538,L0L,838
(1)	970 044 801 66	1 set of trims for dash board, central console and door trim panels	rhd	1	PR:-537, -538,L0R, -838
(1)	970 044 801 67	1 set of trims for dash board, central console and door trim panels	rhd	1	PR:-537, -538,L0R,838
(1)	970 044 801 68	1 set of trims for dash board, central console and door trim panels	rhd	1	PR:538 L0R,-838
(1)	970 044 801 69	1 set of trims for dash board, central console and door trim panels	rhd	1	PR:538, L0R,838
(1)	970 044 801 70	1 set of trims for dash board, central console and door trim panels	rhd	1	PR:537,538, L0R,-838
(1)	970 044 801 71	1 set of trims for dash board, central console and door trim panels	rhd	1	PR:537,538, L0R,838
-		Appendix Package comprising: steering wheel selector lever		1 1	PR:XYA,250
-	970 044 801 72	Interior equipment Appendix Package		1	PR:-639, -640,250
	970 044 801 72 DLC	Black			
	970 044 801 72 6U7	yachting blue			
	970 044 801 72 7A0	Platinum Grey			
	970 044 801 72 8C0	Espresso			
	970 044 801 72 9EF	Cognac			
	970 044 801 72 9H6	Luxor beige			

Model: TEQ 3 Model life 2010>>

Pos	Part Number	Description	Remark	Qty	Model
-	970 044 801 72 8M8 970 044 801 72 PL1 970 044 801 73 970 044 801 73 DLC 970 044 801 73 6U7 970 044 801 73 7A0 970 044 801 73 8C0 970 044 801 73 9EF 970 044 801 73 9H6 970 044 801 73 8M8 970 044 801 73 PL1	Marsala Red D - MJ 2011>> agate grey Interior equipment Appendix Package D - MJ 2011>> Black yachting blue Platinum Grey Espresso Cognac Luxor beige Marsala Red agate grey		1	PR:639,640, 250

Model: TEQ 3

Model life 2010>>

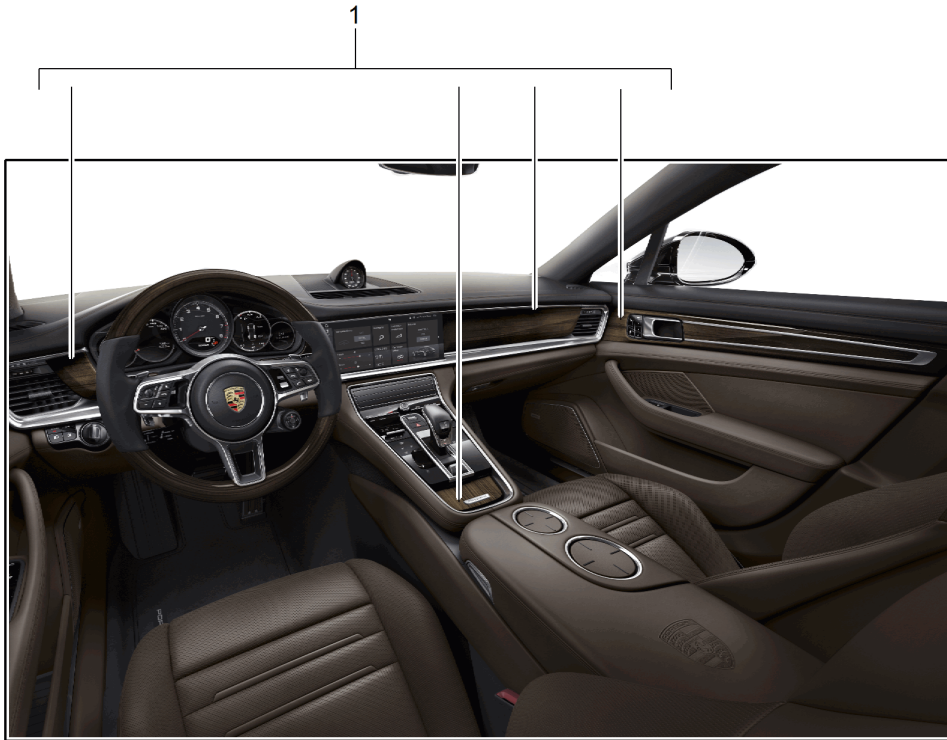

Model: TEQ 3

Model life 2010>>

Pos	Part Number	Description	Remark	Qty	Model
-		Passenger compartment Package Light Paldao D - MJ 2017>> Package comprising: Trim Instrument panel trim Centre console door panel Cover Stowage compartment and Beverages Bracket	front and rear		
1	971 044 830	1 set of trims for dash board, central console and door trim panels		1	PR:L0L,0E1, NZ0,3Z6
(1)	971 044 831	1 set of trims for dash board, central console and door trim panels		1	PR:L0R,0E1, NZ0,3Z6
(1)	971 044 832	1 set of trims for dash board, central console and door trim panels		1	PR:L0L,0E2, NZ0,3Z6
(1)	971 044 833	1 set of trims for dash board, central console and door trim panels		1	PR:L0R,0E2, NZ0,3Z6
(1)	971 044 834	1 set of trims for dash board, central console and door trim panels		1	PR:L0L,0E2, NZ0,1U0,3Z7
(1)	971 044 835	1 set of trims for dash board, central console and door trim panels		1	PR:L0R,0E2, NZ0,1U0,3Z7
(1)	971 044 836	1 set of trims for dash board, central console and door trim panels		1	PR:L0L,0E2, NZ0,1U1,3Z7
(1)	971 044 837	1 set of trims for dash board, central console and door trim panels		1	PR:L0R,0E2, NZ0,1U1,3Z7

Model: TEQ 3

Model life 2010>>

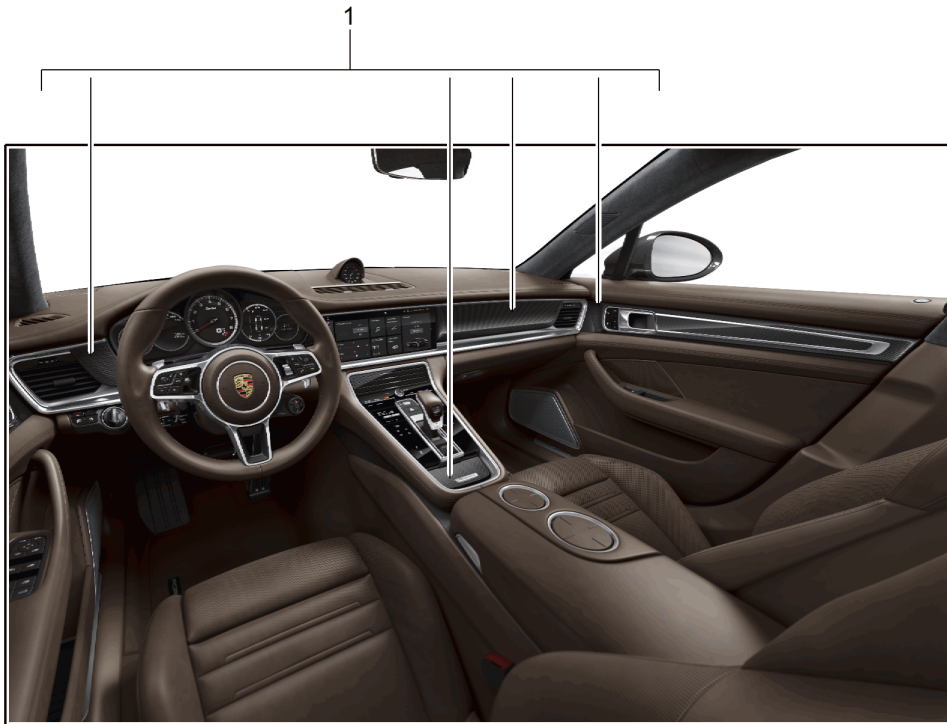

Model: TEQ 3

Model life 2010>>

Pos	Part Number	Description	Remark	Qty	Model
-		Passenger compartment Package Carbon D - MJ 2017>> Package comprising: Trim Instrument panel trim Centre console door panel Cover Stowage compartment and Beverages Bracket	front and rear		
1	971 044 830 A	1 set of trims for dash board, central console and door trim panels		1	PR:L0L,0E1, NZ0,3Z6
(1)	971 044 831 A	1 set of trims for dash board, central console and door trim panels		1	PR:L0R,0E1, NZ0,3Z6
(1)	971 044 832 A	1 set of trims for dash board, central console and door trim panels		1	PR:L0L,0E2, NZ0,3Z6
(1)	971 044 833 A	1 set of trims for dash board, central console and door trim panels		1	PR:L0R,0E2, NZ0,3Z6
(1)	971 044 834 A	1 set of trims for dash board, central console and door trim panels		1	PR:L0L,0E2, NZ0,1U0,3Z7
(1)	971 044 835 A	1 set of trims for dash board, central console and door trim panels		1	PR:L0R,0E2, NZ0,1U0,3Z7
(1)	971 044 836 A	1 set of trims for dash board, central console and door trim panels		1	PR:L0L,0E2, NZ0,1U1,3Z7
(1)	971 044 837 A	1 set of trims for dash board, central console and door trim panels		1	PR:L0R,0E2, NZ0,1U1,3Z7

Model: TEQ 3

Model life 2010>>



Model: TEQ 3

Model life 2010>>

Pos	Part Number	Description	Remark	Qty	Model
1	971 044 880	inscription Lacquered		1	
	971 044 880 041	High-Gloss Black			
	971 044 880 G2X	primed			
1	971 044 880 B	inscription Panamera Turbo Lacquered		1	
	971 044 880 B 041	High-Gloss Black			
	971 044 880 B G2X	primed			

Model: TEQ 3

Model life 2010>>

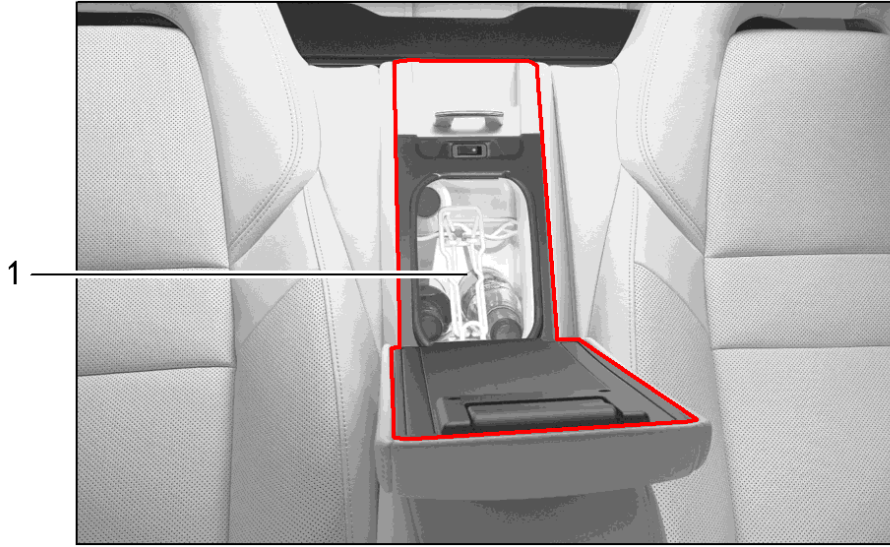

Model: TEQ 3 Model life 2010>>

Pos	Part Number	Description	Remark	Qty	Model
-		Coolbox			OHNE/NOT FOR HYBRID
-		D - MJ 2010>> - MJ 2016			
-		Inst. & Conv. Instructions			
-		Panamera			alle
-		Group 6			
-		6832 (29/09)			
-		Attention			
-		Not for:			PR:626
-		Vehicle			
		with:			
		Charging socket			
		in front of			
		Vehicle Ident. No.			
		F >> 97-AL044 556			S
		F >> 97-AL082 284			Turbo
1	970 044 000 00	Coolbox		1	PR:838
		Set			
		(complete)			
	970 044 000 00 DJ6	Platinum Grey			
	970 044 000 00 DK4	Black			
	970 044 000 00 DM5	Luxor beige			
	970 044 000 00 DP8	Espresso			
	970 044 000 00 DQ9	yachting blue			
	970 044 000 00 DS1	Cognac			
	970 044 000 00 DT2	Marsala Red			
	970 044 000 00 9C0	agate grey			
	970 044 000 00 OP2	saddle brown			
-	970 044 000 01	Glasses		1	
-		Set			
-	970 044 000 02	Grille		1	
-		Set			
-	970 044 000 03	Electric installation set		1	
-	970 044 000 04	Rubber seal	front	1	
-		Coolbox			
-	970 044 000 05	Trim	front	1	
-		Coolbox			
-	970 044 000 06	Operating instructions		1	
-	970 044 000 07	Set of fastening parts		1	
-	970 044 000 08	Cover		1	
		Coolbox			
		Velour			
	970 044 000 08 DJ6	Platinum Grey			
	970 044 000 08 DK4	Black			
	970 044 000 08 DM5	Luxor beige			
	970 044 000 08 DP8	Espresso			
	970 044 000 08 DQ9	yachting blue			
	970 044 000 08 DS1	Cognac			
	970 044 000 08 DT2	Marsala Red			
	970 044 000 08 9C0	agate grey			
	970 044 000 08 OP2	saddle brown			

Model: TEQ 3

Model life 2010>>



Model: TEQ 3 Model life 2010>>

Pos	Part Number	Description	Remark	Qty	Model
		Sport Design package	10-13		OHNE/NOT FOR HYBRID
-		Side member trim also use:	10-16		Panamera / S 4 / 4S Diesel PR:XAP
-	970 701 105 03	Carrier		1	
		Number plate			
		Sport Design package			
-	970 701 105 03 1E0	Black			
		Inst. & Conv. Instructions			
		Panamera			Panamera / S 4 / 4S Turbo
		6658 (1/10)			
		Attention			
1	970 044 802 00	Aerokit	-13	1	PR:288,-XAR, -636,-638
		Set			
		(complete)			
2	970 044 802 01	Aerokit	-13	1	PR:288,-636, -638
		Set			
		without:			
(1)	970 044 802 02	Side member trim			
		Aerokit	-13	1	PR:288,-XAR, 636,638
		Set			
		(complete)			
(2)	970 044 802 03	Aerokit	-13	1	PR:288,636, 638
		Set			
		without:			
(1)	970 044 802 04	Side member trim			
		Aerokit	-13	1	Turbo PR:288,-XAR, 636,638
		Set			
		(complete)			
(2)	970 044 802 05	Aerokit	-13	1	Turbo PR:288,636, 638
		Set			
		without:			
3	970 044 801 98	Side member trim			
		Side member trim	-16	1	alle PR:-XAR,0E1
		Set			
		(complete)			
-		Inst. & Conv. Instructions			
		Panamera			Diesel
		6658 (27/11)			
		Attention			
(1)	970 044 802 06	Aerokit	-13	1	Diesel PR:288,-XAR, -636,-638
		Set			
		(complete)			
(2)	970 044 802 07	Aerokit	-13	1	Diesel PR:288,-636, -638
		Set			
		without:			
(1)	970 044 802 08	Side member trim			
		Aerokit	-13	1	Diesel PR:288,-XAR, 636,638
		Set			
		(complete)			
(2)	970 044 802 09	Aerokit	-13	1	Diesel PR:288,636, 638
		Set			
		without:			
		Side member trim			

Model: TEQ 3

Model life 2010>>

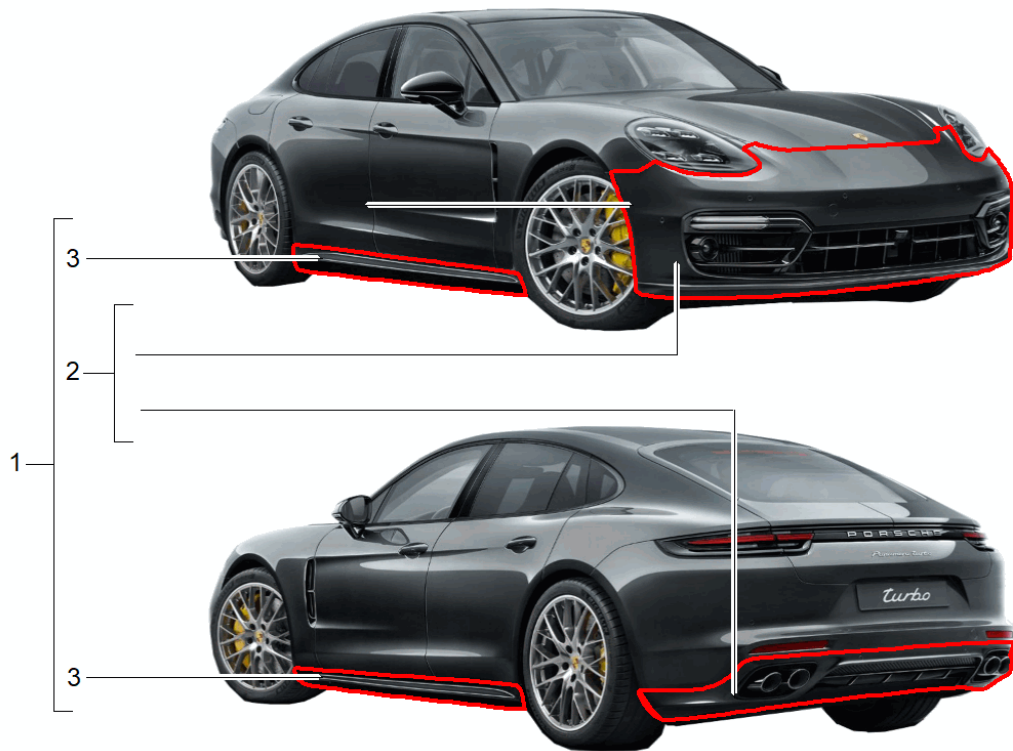

Model: TEQ 3 Model life 2010>>

Pos	Part Number	Description	Remark	Qty	Model
-		Sport Design package Side member trim D - MJ 2017>> Sport Design package comprising: Basic package and Supplement			
1	971 044 860	Sport Design package Basic package primed		1	PR:8X0,0E1
(1)	971 044 860 A	Sport Design package Basic package primed		1	PR:8X1,0E1
(1)	971 044 860 B	Sport Design package Basic package primed		1	PR:8X0,0E2
(1)	971 044 860 C	Sport Design package Basic package primed		1	PR:8X1,0E2
2	971 044 863	Sport Design package Basic package without:		1	PR:8X0
(2)	971 044 863 A	Side member trim primed Sport Design package Basic package without:		1	PR:8X1
3	971 044 866	Side member trim primed Sport Design package Side member trim primed		1	PR:0E1
(3)	971 044 866 A	Sport Design package Side member trim primed		1	PR:0E2
-		also use:			
-	971 044 867	Supplement for Sport Design package Sport Design package Supplement		1	
-	971 044 867 A	Sport Design package Supplement		1	PR:9R1
-	971 044 867 B	Sport Design package Supplement		1	PR:8A4
-	971 044 867 C	Sport Design package Supplement		1	PR:8A4,9R1
-	971 044 867 D	Sport Design package Supplement		1	PR:3V1,8T3
-	971 044 867 E	Sport Design package Supplement		1	PR:9R1,3V1, 8T3
-	971 044 867 F	Sport Design package Supplement		1	PR:8A4,8T3, 3V1
-	971 044 867 G	Sport Design package Supplement		1	PR:8A4,9R1, 8T3,3V1
-	971 807 999 P	use if required: Assembly kit Number plate primed		1	PR:6W7 "CN."
-	971 807 999 P G2X				
-	971 807 999 Q	Assembly kit Number plate primed		1	PR:6W2
-	971 807 999 Q G2X				

Model: TEQ 3 Model life 2010>>

Pos	Part Number	Description	Remark	Qty	Model
-	971 807 999 N 971 807 999 N G2X	Assembly kit Number plate primed		1	PR:6W4 "J.."

Model: TEQ 3

Model life 2010>>

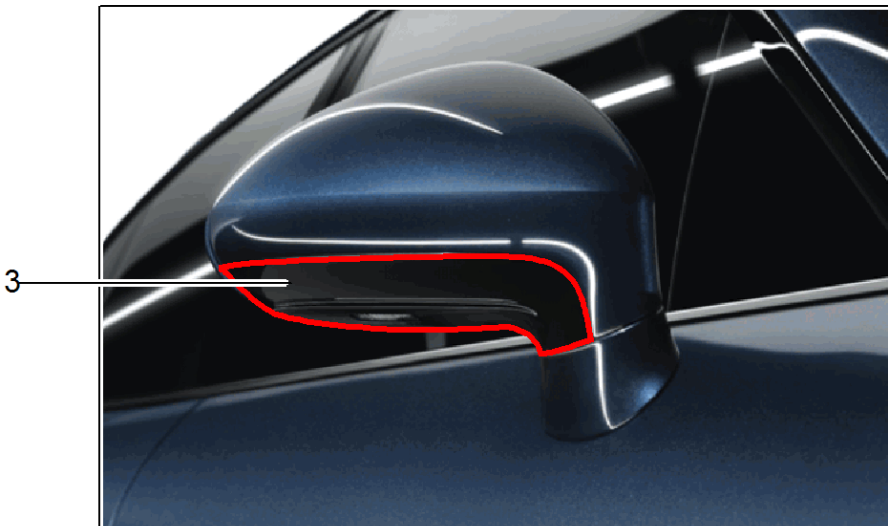
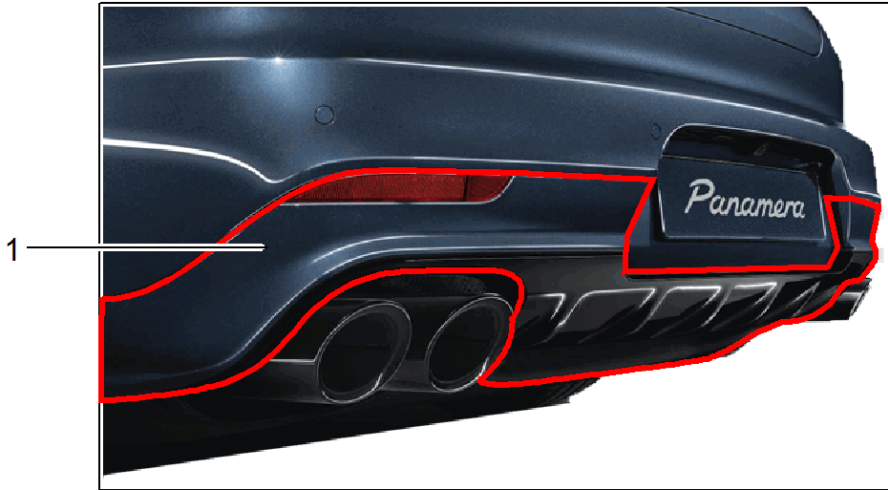

Model: TEQ 3 Model life 2010>>

Pos	Part Number	Description	Remark	Qty	Model
1	970 044 803 00	Body parts Lacquered D >> - MJ 2016 1 set trims Rear end Lower part primed	outer	1	
(1)	970 044 803 20	D - MJ 2015>> - MJ 2016 1 set trims Rear end Lower part primed		1	
2	970 044 802 85	D - MJ 2016>> Trim Wing primed Set		1	
3	970 044 802 90	D - MJ 2015>> Exterior mirror Bottom half primed Set		1	/LL PR:258,-633, 260
(3)	970 044 802 91	D - MJ 2015>> Exterior mirror Bottom half primed Set		1	/RL PR:258,-633, 260
(3)	970 044 802 92	D - MJ 2015>> Exterior mirror Bottom half primed Set		1	/LL PR:259,-633, 261
(3)	970 044 802 93	D - MJ 2015>> Exterior mirror Bottom half primed Set		1	/RL PR:259,-633, 261
(3)	970 044 802 94	D - MJ 2015>> Exterior mirror Bottom half primed Set		1	/LL PR:258,633, 260
(3)	970 044 802 95	D - MJ 2015>> Exterior mirror Bottom half primed Set		1	/RL PR:258,633, 260
(3)	970 044 802 96	D - MJ 2015>> Exterior mirror Bottom half primed Set		1	/LL PR:259,633, 261
(3)	970 044 802 97	D - MJ 2015>> Exterior mirror Bottom half primed Set D - MJ 2015>>		1	/RL PR:259,633, 261

Model: TEQ 3

Model life 2010>>

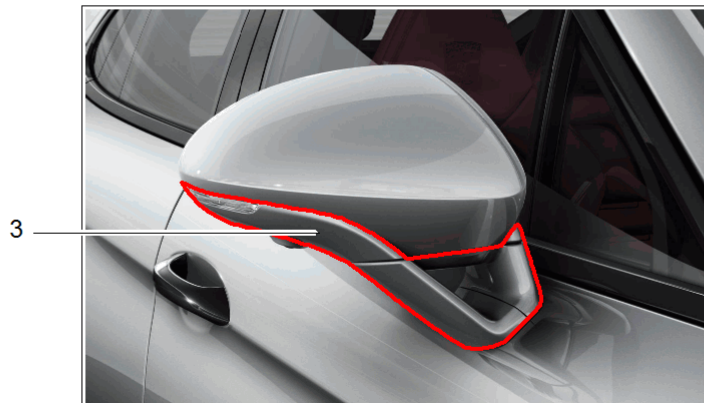

Model: TEQ 3 Model life 2010>>

Pos	Part Number	Description	Remark	Qty	Model
1	971 044 840	Body parts D - MJ 2017>> Trim Wing primed Set	outer painted 2-part	1	
2	971 044 850	Exterior mirror Top half primed for High-Gloss Black Set	2-part	1	PR:L0L,7Y0
(2)	971 044 850 A	Exterior mirror Top half primed for High-Gloss Black Set	2-part	1	PR:L0R,7Y0
(2)	971 044 850 B	Exterior mirror Top half primed for High-Gloss Black Set	2-part	1	PR:L0L,7Y1
(2)	971 044 850 C	Exterior mirror Top half primed for High-Gloss Black Set	2-part	1	PR:L0R,7Y1
3	971 044 851	Exterior mirror Bottom half and Mirror base primed Set		1	PR:L0L
(3)	971 044 851 A	Exterior mirror Bottom half and Mirror base primed Set		1	PR:L0R
(3)	971 044 851 B	Exterior mirror Bottom half and Mirror base primed Set		1	PR:L0R,8A4
(3)	971 044 851 C	Exterior mirror Bottom half and Mirror base primed Set		1	PR:L0R,8A4

Model: TEQ 3

Model life 2010>>

1



Model: TEQ 3 Model life 2010>>

Pos	Part Number	Description	Remark	Qty	Model
-		Porsche VEHICLE TRACKING SYSTEME D - MJ 2010>> - MJ 2014 Inst. & Conv. Instructions Panamera Group 9 9063 (14/09; 15/09) Attention			S / Turbo
1	970 044 900 05	Immobiliser Porsche Vehicle Tracking System Continental F >> 97-AL046 440 F >> 97-AL083 290 D - MJ 2010>> - MJ 2010		1	PR:674
-		Inst. & Conv. Instructions Panamera Group 9 9063 (13/09; 15/09) Attention			S / Turbo
(1)	970 044 900 06	Immobiliser Porsche Vehicle Tracking System Advanced F >> 97-AL046 440 F >> 97-AL083 290 D - MJ 2010>> - MJ 2010		1	PR:674
-		Inst. & Conv. Instructions Panamera Group 9 9063 (1/09) Attention			S / Turbo
(1)	970 044 900 07	Immobiliser Porsche Vehicle Tracking System Autonome / Integrated F >> 97-AL046 440 F >> 97-AL083 290 D - MJ 2010>> - MJ 2010		1	PR:674
-		also use:			
-	970 044 900 14	Accessories for 970.044.900.05 /06 /07 D - MJ 2010>> - MJ 2010		1	PR:674
-	970 044 900 15	Accessories for 970.044.900.05 /06 /07 D - MJ 2010>> - MJ 2010		1	PR:206,674
-		Inst. & Conv. Instructions Panamera Group 9 9063 (17/10) Attention			alle
(1)	955 044 905 00	Immobiliser Porsche VEHICLE TRACKING SYSTEM CONTINENTAL F 97-AL046 441>> F 97-AL083 291>> D - MJ 2010>> - MJ 2014		1	PR:674
-		Inst. & Conv. Instructions Panamera Group 9			alle

Model: TEQ 3 Model life 2010>>

Pos	Part Number	Description	Remark	Qty	Model
(1)	955 044 905 01	9063 (4/10) Attention Immobiliser Porsche VEHICLE TRACKING SYSTEM ADVANCED F 97-AL046 441>> F 97-AL083 291>> D - MJ 2010>> - MJ 2014		1	PR:674
-		Inst. & Conv. Instructions Panamera Group 9			S Turbo alle
(1)	955 044 905 02	9063 (16/10) Attention Immobiliser Porsche VEHICLE TRACKING SYSTEM AUTONOME / INTEGRATED F 97-AL046 441>> F 97-AL083 291>> D - MJ 2010>> - MJ 2014		1	PR:674
-		also use:			S Turbo
-	970 044 900 16	Accessories for 955.044.905.00/01/02 D - MJ 2010>> - MJ 2014		1	PR:674
-	970 044 900 17	Accessories for 955.044.905.00/01/02 D - MJ 2010>> - MJ 2014		1	PR:206,674
-		Only for replacement Order			
-	970 044 900 18	repair set for Porsche Vehicle Tracking System		1	PR:674

Model: TEQ 3

Model life 2010>>

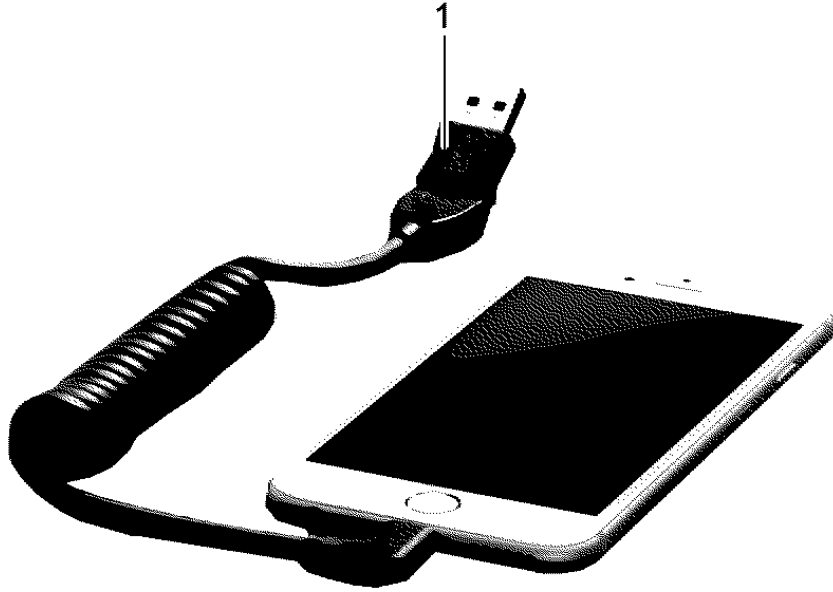

Model: TEQ 3 Model life 2010>>

Pos	Part Number	Description	Remark	Qty	Model
1	970 044 901 50	Charging cable USB connection cable		1	
(1)	970 044 901 51	USB connection cable APPLE		1	
(1)	970 044 901 52	USB connection cable MICRO USB	Type: USB-C	1	

Model: TEQ 3

Model life 2010>>

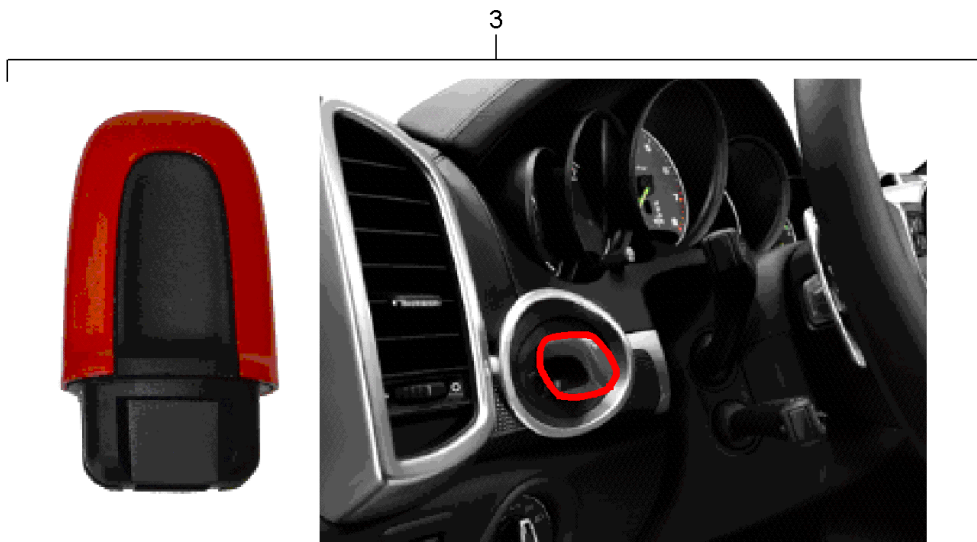
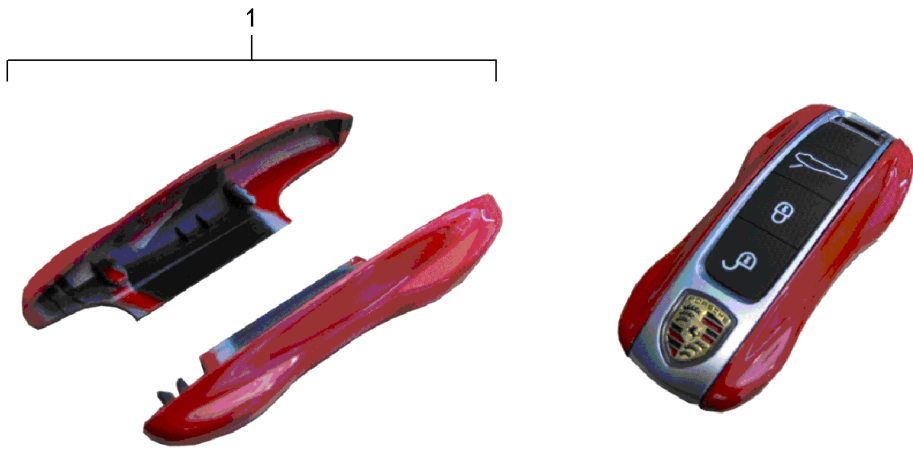

Model: TEQ 3 Model life 2010>>

Pos	Part Number	Description	Remark	Qty	Model
-		Key cover Ignition/starter switch Exterior body colour note: Inst. & Conv. Instructions 9662 (63/12) 9662 (41/16)	10-16 17-		alle
1	971 044 801	Key cover	-16 17- 17- painted	1	
		Set			
	971 044 801 C1Y	Palladium Metallic			
	971 044 801 C5M	Moonlight Blue Metallic			
	971 044 801 C9A	white			
	971 044 801 C9X	Jet Black Metallic			
	971 044 801 M2A	Lava Orange			
	971 044 801 M3C	Carmine red			
	971 044 801 M3S	Burgundy Red Metallic			
	971 044 801 M4W	Purpurite Metallic			
	971 044 801 M4Z	Amethyst metallic			
	971 044 801 M5C	miami blue			
	971 044 801 M5E	Biscay Blue Metallic			
	971 044 801 M5F	Midnight Blue Metallic			
	971 044 801 M5J	Sapphire Blue Metallic			
	971 044 801 M6B	Lizard green			
	971 044 801 M6S	Mamba green metallic			
	971 044 801 M6T	Aventurine green metallic			
	971 044 801 M7P	Dolomite silver metallic			
	971 044 801 M7Q	Quartzite Grey Metallic			
	971 044 801 M7R	Volcano Grey Metallic			
	971 044 801 M7S	Achat Grey Metallic			
	971 044 801 M7U	Rhodium Silver Metallic			
	971 044 801 M7Z	GT Silver Metallic			
	971 044 801 M8R	Ristretto Brown Metallic			
	971 044 801 M8Y	Mahogany Metallic			
	971 044 801 M9A	Chalk			
	971 044 801 S9R	Carrara White metallic			
	971 044 801 041	Black			
	971 044 801 1S1	Racing Yellow			
	971 044 801 84A	guards red (Porsche)			
2	991 044 801 20	Key cover	-16 painted	1	
		Set			
	991 044 801 20 A6W	Crystal green metallic Discontinued part			
	991 044 801 20 C1Y	Palladium Metallic			
	991 044 801 20 C5M	Moonlight Blue Metallic			
	991 044 801 20 C9A	white			
	991 044 801 20 C9X	Jet Black Metallic			
	991 044 801 20 C9Z	Basalt black metallic			
	991 044 801 20 H8Z	Chestnut Brown Metallic Discontinued part			
	991 044 801 20 M1R	Aurum Metallic			
	991 044 801 20 M1S	Luxor Beige Metallic Discontinued part			
	991 044 801 20 M2A	Lava Orange			
	991 044 801 20 M3C	Carmine red			
	991 044 801 20 M3T	Auburn Metallic Discontinued part			
	991 044 801 20 M3X	Ruby red metallic			
	991 044 801 20 M4A	Ultraviolet			
	991 044 801 20 M4W	Purpurite Metallic			
	991 044 801 20 M4Z	Amethyst metallic			
	991 044 801 20 M5C	miami blue			

Model: TEQ 3 Model life 2010>>

Pos	Part Number	Description	Remark	Qty	Model
	991 044 801 20 M5F	Midnight Blue Metallic			
	991 044 801 20 M5G	Graphite Blue Metallic			
	991 044 801 20 M5J	Sapphire Blue Metallic			
	991 044 801 20 M5R	Aqua blue metallic Discontinued part			
	991 044 801 20 M5S	Yachting Blue Metallic			
	991 044 801 20 M5X	Dark blue metallic			
	991 044 801 20 M7R	Volcano Grey Metallic			
	991 044 801 20 M7S	Achat Grey Metallic			
	991 044 801 20 M7T	Platinum Silver Metallic Discontinued part			
	991 044 801 20 M7U	Rhodium Silver Metallic			
	991 044 801 20 M7W	Meteor Grey Metallic			
	991 044 801 20 M7Z	GT Silver Metallic			
	991 044 801 20 M8S	Anthracite Brown Metallic			
	991 044 801 20 M8U	Umbra Metallic			
	991 044 801 20 M8X	Topaz Brown Metallic Discontinued part			
	991 044 801 20 M8Y	Mahogany Metallic			
	991 044 801 20 M8Z	Cognac Metallic			
	991 044 801 20 M9Z	Carbon Grey Metallic Discontinued part			
	991 044 801 20 S9R	Carrara White metallic			
	991 044 801 20 X7W	Classic Silver Metallic			
	991 044 801 20 Z6H	Jet Green Metallic			
	991 044 801 20 041	Black			
	991 044 801 20 1S1	Racing Yellow			
	991 044 801 20 2G6	emerald green metallic Discontinued part			
	991 044 801 20 2S1	Peridot Metallic			
	991 044 801 20 5P1	Lime Gold Metallic			
	991 044 801 20 7B2	agate grey			
	991 044 801 20 8L1	Amaranth Red Metallic			
	991 044 801 20 8M5	Impulse Red Metallic			
	991 044 801 20 84A	guards red (Porsche)			
	991 044 801 20 9G5	Geyser Grey Metallic			
(2)	991 044 801 22	Key cover	Painted	1	
		Set			
	991 044 801 22 M6B	Lizard green			
	991 044 801 22 M6S	Mamba green metallic			
	991 044 801 22 M7P	Dolomite silver metallic			
3	991 044 801 21	Ignition/starter switch	-16 Painted	1	PR:625
	991 044 801 21 041	Black			
	991 044 801 21 1S1	Racing Yellow			
	991 044 801 21 2S1	Peridot Metallic			
	991 044 801 21 5P1	Lime Gold Metallic			
	991 044 801 21 84A	guards red (Porsche)			
	991 044 801 21 8M5	Impulse Red Metallic			
	991 044 801 21 C1Y	Palladium Metallic			
	991 044 801 21 C5M	Moonlight Blue Metallic			
	991 044 801 21 C9A	white			
	991 044 801 21 C9X	Jet Black Metallic			
	991 044 801 21 H8Z	Chestnut Brown Metallic Discontinued part			
	991 044 801 21 M1R	Aurum Metallic			
	991 044 801 21 M2A	Lava Orange			
	991 044 801 21 M3C	Carmin red			
	991 044 801 21 M3X	Ruby red metallic			
	991 044 801 21 M4A	Ultraviolet			
	991 044 801 21 M4W	Purpurite Metallic			
	991 044 801 21 M4Z	Amethyst metallic			

Model: TEQ 3 Model life 2010>>

Pos	Part Number	Description	Remark	Qty	Model
	991 044 801 21 M5C	miami blue			
	991 044 801 21 M5F	Midnight Blue Metallic			
	991 044 801 21 M5G	Graphite Blue Metallic			
	991 044 801 21 M5J	Sapphire Blue Metallic			
	991 044 801 21 M5S	Yachting Blue Metallic			
	991 044 801 21 M5X	Dark blue metallic			
	991 044 801 21 M6B	Lizard green			
	991 044 801 21 M6S	Mamba green metallic			
	991 044 801 21 M6T	Aventurine green metallic			
	991 044 801 21 M7P	Dolomite silver metallic			
	991 044 801 21 M7R	Volcano Grey Metallic			
	991 044 801 21 M7S	Achat Grey Metallic			
	991 044 801 21 M7U	Rhodium Silver Metallic			
	991 044 801 21 M7W	Meteor Grey Metallic			
	991 044 801 21 M7Z	GT Silver Metallic			
	991 044 801 21 M8S	Anthracite Brown Metallic			
	991 044 801 21 M8U	Umbra Metallic			
	991 044 801 21 M8Y	Mahogany Metallic			
	991 044 801 21 M8Z	Cognac Metallic			
	991 044 801 21 M9A	Chalk			
	991 044 801 21 M9Z	Carbon Grey Metallic Discontinued part			
	991 044 801 21 S9R	Carrara White metallic			

Model: TEQ 3

Model life 2010>>



Model: TEQ 3 Model life 2010>>

Pos	Part Number	Description	Remark	Qty	Model
1	970 044 000 14	Connection line Power supply Hybrid Connection line Power supply Black MODE 3 / TYP 2 7,5 M Set with: Pocket	13-16 15-17	1	PHEV G1 PHEV E2 PHEV -"USA", -"J..", -"AUS", -"CN.", -"PLA", -"CDN", -"BR."
2	971 044 000	Connection line Power supply Black MODE 3 / TYP 2 7,5 M Set with: Pocket	17-	1	G2 PHEV -"USA", -"J..", -"AUS", -"CN.", -"PLA", -"CDN", -"BR."

Model: TEQ 3

Model life 2010>>

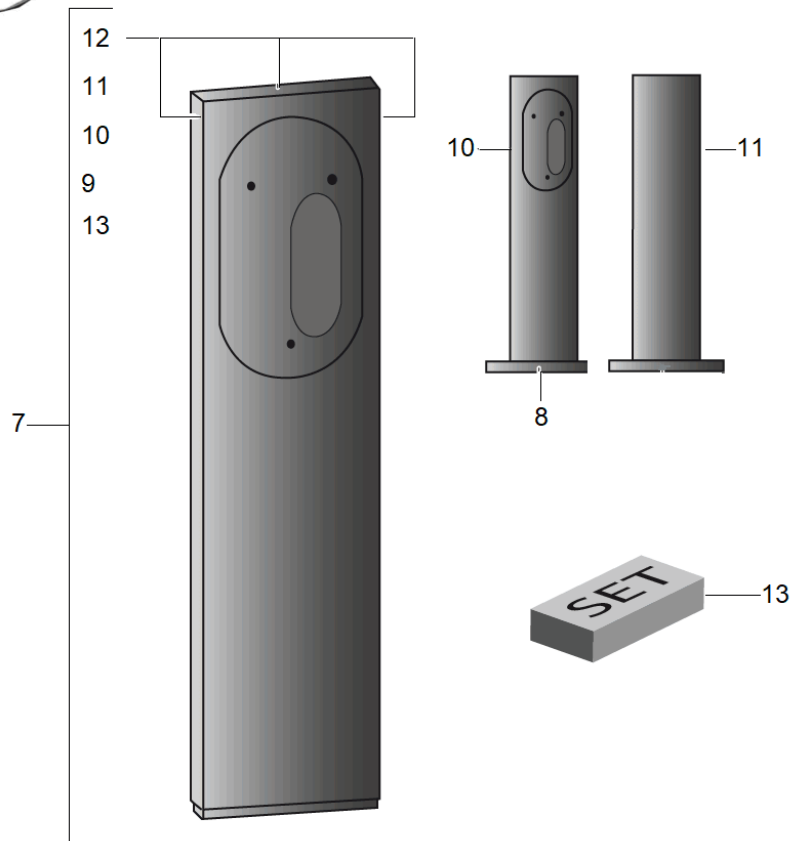
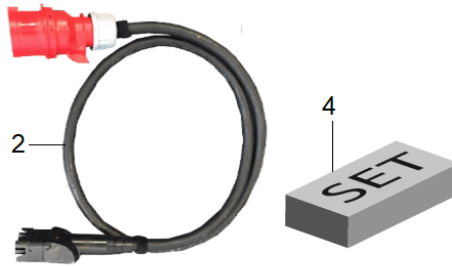

Model: TEQ 3 Model life 2010>>

Pos	Part Number	Description	Remark	Qty	Model
1	971 044 030	Stand Power supply Hybrid Stand 167X19X15 CM Charging socket Hybrid with: PORSCHE logo without: Charger without: Connection line also use:	971 044 035 971 044 035 A 7PP 971 678 BA	1	PHEV
2	971 044 035	Connection line Power supply CEE 3P 32A		1	PR:73K,73H, 73L -"I..","J.."
(2)	971 044 035 A	Connection line Power supply CEE 1P 32A		1	PR:73K -"USA", -"J.."
-		Only for replacement			PR:73H -"USA", -"J.."
3	971 044 031	Bracket Connector Included Set		1	
4	971 044 032	Adapter plug Set of fastening parts base plate Stand		1	
5	971 044 033	Operating instructions Stand		1	
6	971 044 034	key Stand		1	
7	970 044 000 70	State lock number Stand 167X42X10 CM Charging socket Hybrid Glasses box with: PORSCHE logo without: Charging Dock without: Connection line use if required:		1	
8	970 044 000 76	Post bracket for Trade equipment Lower part 88X84X8 CM Movable Stand Charging socket Hybrid		1	
(8)	970 044 000 77	Lower part 75X75X3 CM Fixed		1	

Model: TEQ 3 Model life 2010>>

Pos	Part Number	Description	Remark	Qty	Model
-		Stand Charging socket Hybrid Only for replacement			
-		note: Inst. & Conv. Instructions 0941 (02/18)			
-	970 044 000 78	Modification kit Charging station Black, glass optical for Charger		1	
		additionally to be used items:	970 044 000 72	1	
			970 044 000 73	1	
-	970 044 000 79	Modification kit Charging station Black, glass optical for Charger	2 parts	1	
		additionally to be used items:	970 044 000 72	2	
(9)	970 044 000 71	Stand Charging socket Hybrid Frame		1	
10	970 044 000 72	Interior frame Stand Charging socket Hybrid Washer	front	1	
		Charging Dock	without:		
			without:		
11	970 044 000 73	Connection line Stand Charging socket Hybrid Washer	rear	1	
12	970 044 000 74	Side panel trim Stand Charging socket Hybrid		1	
13	970 044 000 75	Set 3-part Set of fastening parts Stand Charging socket Hybrid		1	

Model: TEQ 3

Model life 2010>>



Model: TEQ 3 Model life 2010>>

Pos	Part Number	Description	Remark	Qty	Model
1	970 044 901 38	Supplement Air conditioning Module heater Hybrid Supplement Air conditioning heater Coding VIA PRMS D - MJ 2013>>		1	PHEV G1 PHEV

Model: TEQ 3

Model life 2010>>



Model: TEQ 3 Model life 2010>>

Pos	Part Number	Description	Remark	Qty	Model
1	955 044 900 55	Charger Cigarette lighter D - MJ 2010>>		1	/230 V "GB."
(1)	955 044 900 56	Charger 12 V		1	/230 V
2	958 044 900 70	Charger EUROPA/RUSSLAND 220-240 V / 5,0 A		1	Charge-o-mat Pro
(2)	958 044 900 72	Charger Great britain 220-240 V / 5,0 A		1	Charge-o-mat Pro "GB."
(2)	958 044 900 73	Charger CHINA 220-240 V / 5,0 A		1	Charge-o-mat Pro "CN."
(2)	958 044 900 74	Charger Japan 110-120 V / 4,3 A		1	Charge-o-mat Pro "J.."
3	958 044 900 75	Adapter for Charger		1	
-		Only for replacement			
4	958 044 900 76	Connector Cigarette lighter		1	

Model: TEQ 3

Model life 2010>>

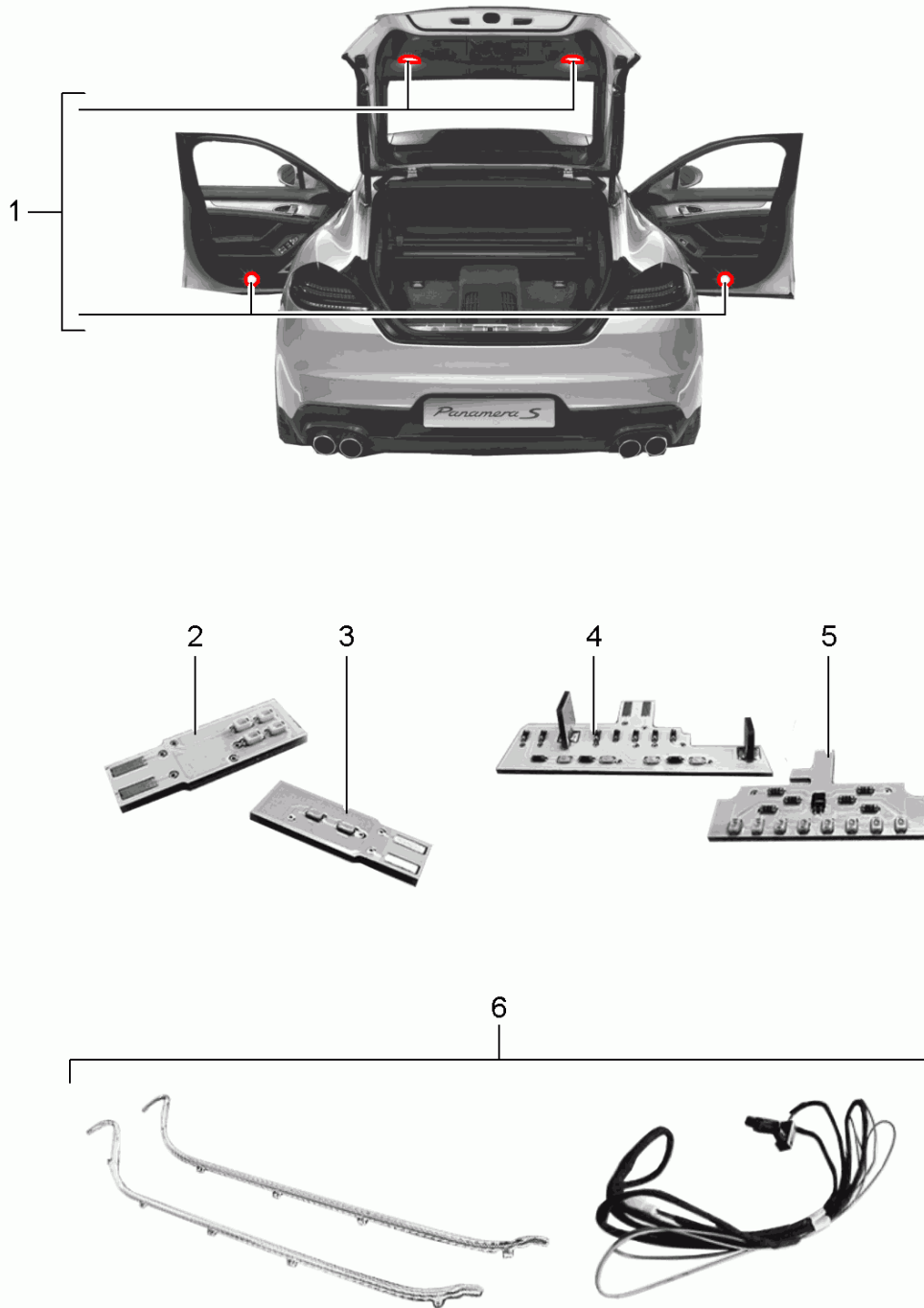

Model: TEQ 3 Model life 2010>>

Pos	Part Number	Description	Remark	Qty	Model
-		LED module Passenger compartment Inst. & Conv. Instructions	10-16 10-13		alle
1	970 044 901 20	Panamera Group 9 9652 (26/11) Attention LED module Passenger compartment Set	10-16	1	PR:-630
(1)	970 044 901 21	LED module Passenger compartment Set	10-13	1	PR:630
-		Inst. & Conv. Instructions Panamera Group 9 9652 (49/13) Attention	14-16		alle
(1)	970 044 901 29	LED module Passenger compartment Set	14-16	1	PR:630,0E1
(1)	970 044 901 30	LED module Passenger compartment Set	14-16	1	PR:630,0E2
-		Only for replacement Order			
2	970 044 901 22	LED module Door		1	
3	970 044 901 23	LED module Footwell Glove box Luggage compartment		1	
4	970 044 901 24	LED module Luggage compartment Cover		1	
5	970 044 901 25	LED module Sun visor		1	
6	970 044 901 26	LED module strip Centre console Included Cable Set	left a. right	1	

Model: TEQ 3

Model life 2010>>

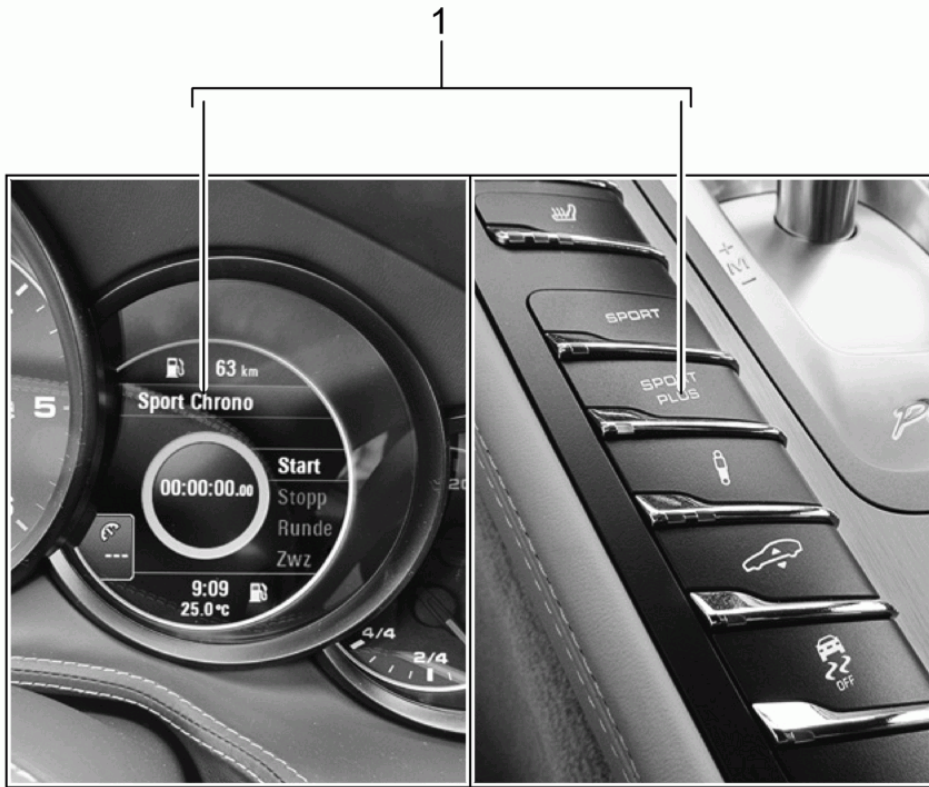

Model: TEQ 3 Model life 2010>>

Pos	Part Number	Description	Remark	Qty	Model
-		Strip for switches SPORT PLUS D - MJ 2010>> - MJ 2016 Inst. & Conv. Instructions Panamera Group 9 9627 (39/12) Attention			alle
1	970 044 900 21	Control panel with pushbuttons SPORT PLUS Coding VIA PRMS		1	PR:029,639, 640
(1)	970 044 900 22	Control panel with pushbuttons SPORT PLUS Coding VIA PRMS		1	PR:475,639, 640
(1)	970 044 900 23	Control panel with pushbuttons SPORT PLUS Coding VIA PRMS		1	PR:639,640, 350,351,354, 355

Model: TEQ 3

Model life 2010>>

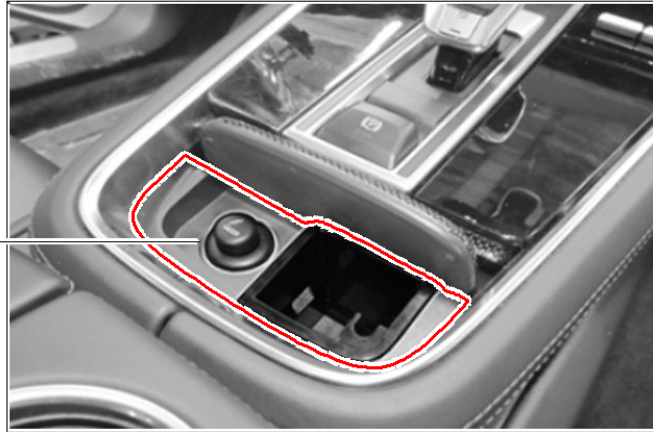

1

Model: TEQ 3 Model life 2010>>

Pos	Part Number	Description	Remark	Qty	Model
-		Smoker package D - MJ 2017>> Inst. & Conv. Instructions Group 6 6820 (16/17) Attention			
1	971 044 907	Retrofit kit Smoker package D - MJ 2017>>		1	

Model: TEQ 3

Model life 2010>>



Model: TEQ 3

Model life 2010>>

Pos	Part Number	Description	Remark	Qty	Model
1	970 044 900 50	Headlights INNENBLLENDE Black Headlights SATZ D - MJ 2010>> - MJ 2013		1	PR:603 -"IND"
(1)	970 044 900 51	Headlights SATZ D - MJ 2010>> - MJ 2013		1	Turbo PR:604 -"IND"
-	970 044 900 54	LED headlight SATZ D - MJ 2014>>		1	PR:632
-	970 044 900 56	Headlights SATZ D - MJ 2014>>		1	PR:620
(1)	971 044 903	Headlights SATZ	14-16 PR : 8JU/8IU 17-	1	

Model: TEQ 3

Model life 2010>>

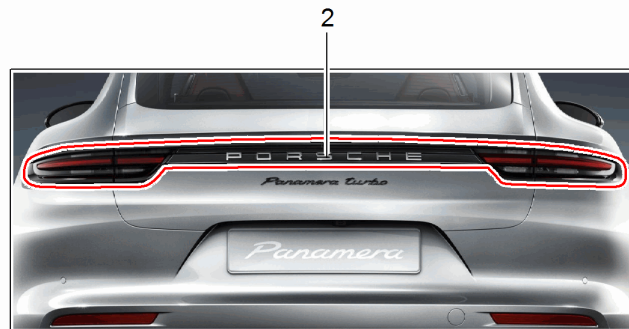
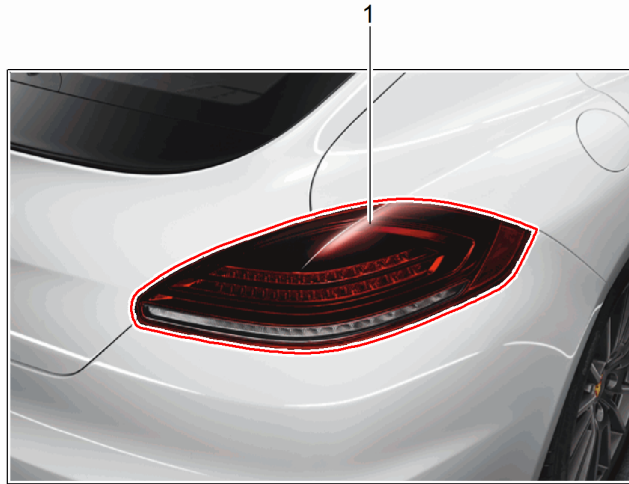

Model: TEQ 3 Model life 2010>>

Pos	Part Number	Description	Remark	Qty	Model
1	970 044 901 55	Rear light Black-red D - MJ 2014>> Rear light Set	drive on right	1	
(1)	970 044 901 56	D >> - MJ 2016 Rear light Set	drive on left	1	
2	971 044 900	D >> - MJ 2016 Rear light Dark Included Reflector cover Set	drive on right	1	
(2)	971 044 901	D - MJ 2017>> Rear light Dark Included Reflector cover Set D - MJ 2017>>	drive on left	1	

Model: TEQ 3

Model life 2010>>



Model: TEQ 3

Model life 2010>>

Pos	Part Number	Description	Remark	Qty	Model
-		Navigation system PCM3.1 Included DVD device D - MJ 2010>> - MJ 2016 Inst. & Conv. Instructions Panamera Group 9 9110 (27/10)			alle
1	970 044 901 90	PCM 3 with: Navigation Set Europe Coding VIA PRMS D - MJ 2010>>		1	PR:680,682, 490
(1)	970 044 901 92	PCM 3 with: Navigation Set AUSTRALIA Coding VIA PRMS D - MJ 2010>>		1	PR:680,682, 490 "AUS"
(1)	970 044 901 93	PCM 3 with: Navigation Set SOUTH AFRICA Coding VIA PRMS D - MJ 2010>>		1	PR:680,682, 490 "ZA."
(1)	970 044 901 94	PCM 3 with: Navigation Set MIDDLE EAST Coding VIA PRMS D - MJ 2013>>		1	PR:680,682, 490 "PME"
(1)	970 044 901 95	PCM 3 with: Navigation Set ASIA/PAZIFIC Coding VIA PRMS D - MJ 2010>>		1	PR:680,682, 490 "HK."
(1)	970 044 901 96	PCM 3 with: Navigation Set RUSSIA Coding VIA PRMS D - MJ 2010>>		1	PR:680,682, 490 "RUS"
(1)	970 044 901 97	PCM 3 with: Navigation Set ARGENTINIEN		1	PR:680,682, 490,77J "PLA"

Model: TEQ 3 Model life 2010>>

Pos	Part Number	Description	Remark	Qty	Model
(1)	970 044 901 98	Coding VIA PRMS D - MJ 2010>> PCM 3 with: Navigation Set CHILE Coding VIA PRMS D - MJ 2010>>		1	PR: 680,682, 490,77K "PLA"

Model: TEQ 3

Model life 2010>>

1



**Licence Key for
PCM 3.0 / PCM 3.1 Navigation Database Europe
Sportscar / Panamera 04.2015**

2



Model: TEQ 3

Model life 2010>>

Pos	Part Number	Description	Remark	Qty	Model
-		Navigation PCM3.1-UPDATE D - MJ 2010>> - MJ 2016 Inst. & Conv. Instructions Panamera Group 9 9110 (47/15) Attention			
1	997 044 908 60	Software PCM3.1-UPDATE Europe 04/2015 Together with Country equipment Note coding		1	
(1)	997 044 908 62	Software PCM3.1-UPDATE AUSTRALIA / NEW ZEALAND 04/2015 Together with Country equipment Note coding		1	"AUS"
(1)	997 044 908 63	Software PCM3.1-UPDATE SOUTH AFRICA 04/2015 Together with Country equipment Note coding		1	"ZA."
(1)	997 044 908 64	Software PCM3.1-UPDATE MIDDLE EAST 04/2015 Together with Country equipment Note coding		1	"PME"
(1)	997 044 908 65	Software PCM3.1-UPDATE ASIA / PAZIFIC 04/2015 Together with Country equipment Note coding		1	"HK."
(1)	997 044 908 66	Software PCM3.1-UPDATE RUSSIA 04/2015 Together with Country equipment Note coding		1	"RUS"
(1)	997 044 908 67	Software PCM3.1-UPDATE CHINA 04/2015 Together with Country equipment Note coding		1	"CN."
(1)	997 044 908 68	Software PCM3.1-UPDATE ARGENTINIEN 04/2015 Together with Country equipment Note coding		1	"PLA"
(1)	997 044 908 69	Software PCM3.1-UPDATE		1	"PLA"

Model: TEQ 3 Model life 2010>>

Pos	Part Number	Description	Remark	Qty	Model
-		CHILE 04/2015 Together with Country equipment Note coding Inst. & Conv. Instructions Group 9 REAL TIME TRAFFIC 9110 (08/16) Internet 9940 (37/13) Attention			
2	997 044 908 70	Software PCM3.1-UPDATE REAL TIME TRAFFIC Information Europe 04/2015 Together with Country equipment Note coding		1	
(2)	997 044 908 80	D - MJ 2013>> - MJ 2016 Software PCM3.1-UPDATE REAL TIME TRAFFIC Information with: Internet Europe 04/2015 Coding VIA PRMS D - MJ 2013>> - MJ 2016		1	

Model: TEQ 3

Model life 2010>>

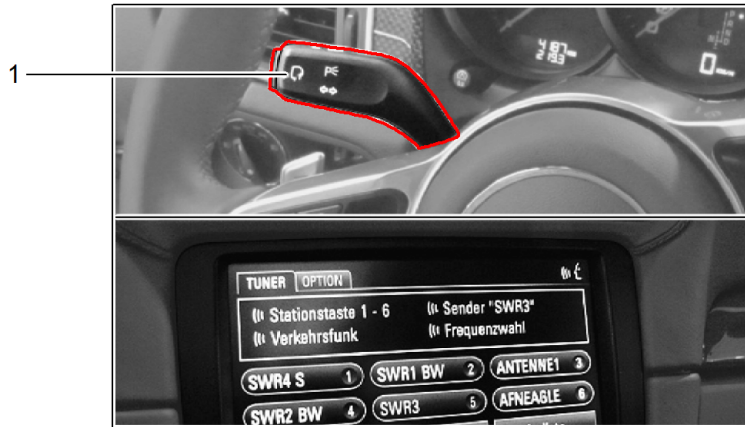

Model: TEQ 3

Model life 2010>>

Pos	Part Number	Description	Remark	Qty	Model
-		Voice control system PCM 4 Inst. & Conv. Instructions Group 9 9152 (14/17) Attention	17-		Panamera G2
1	982 044 900 04	Module Voice control system for vehicles with PCM 4 Included Navigation	17-	1	"USA", "CN."

Model: TEQ 3

Model life 2010>>

1

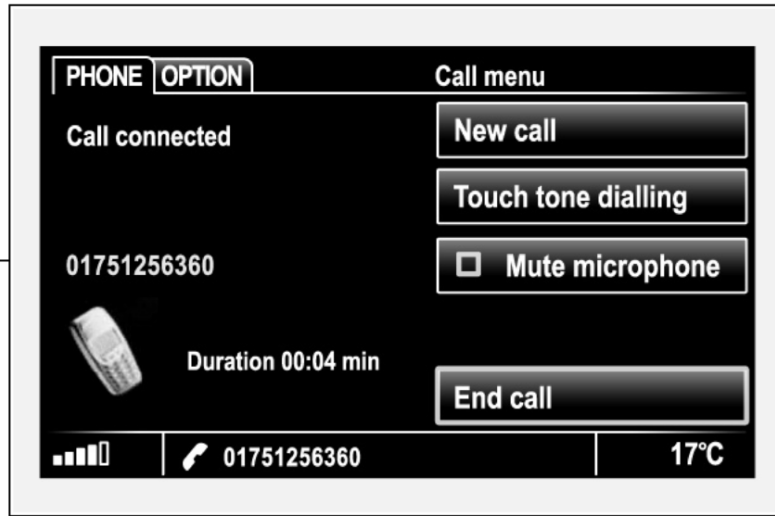

2



Model: TEQ 3 Model life 2010>>

Pos	Part Number	Description	Remark	Qty	Model
-		Module Telephone Receiver D - MJ 2010>> - MJ 2016 Inst. & Conv. Instructions Panamera Group 9 9155 (18/09) Attention			alle
1	970 044 900 30	Module Telephone Set only in conj. with: PCM 3.1 Coding VIA PRMS		1	
(1)	970 044 901 33	D - MJ 2010>> - MJ 2013 Module Telephone Set only in conj. with: PCM3.1 or CDR PLUS Coding VIA PRMS		1	
-		D - MJ 2014>> use if required: Console Roof see illustration:			PR:-193 -"J.."
-		Panamera 903-06 Inst. & Conv. Instructions Panamera Group 9 9191 (21/09) Attention			alle
2	970 044 900 31	Receiver Set only in conj. with: Telephone Module D - MJ 2010>>		1	

Model: TEQ 3

Model life 2010>>

1

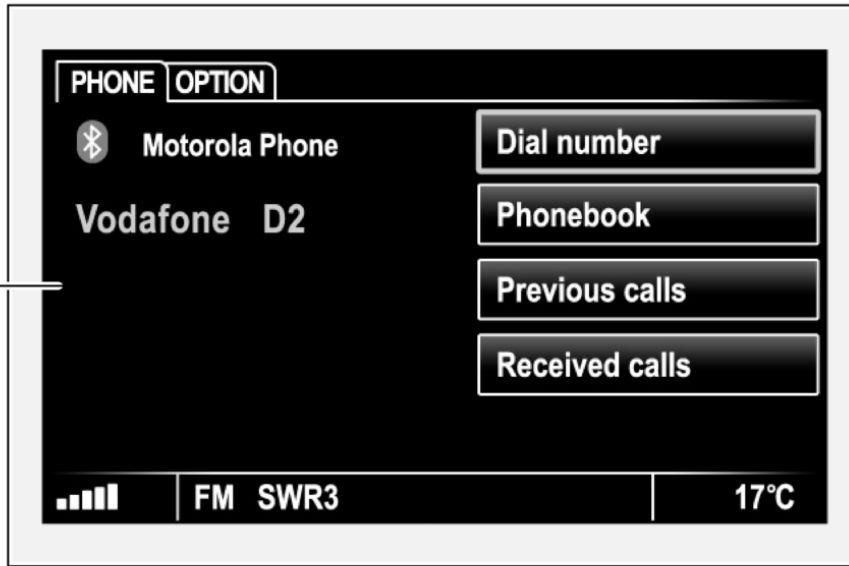

Model: TEQ 3 Model life 2010>>

Pos	Part Number	Description	Remark	Qty	Model
-		Mobile Hands-free equipment D - MJ 2010>> - MJ 2016 Inst. & Conv. Instructions Panamera Group 9 9187 (20/09) Attention			alle
-		Console use if required: Roof see illustration: Panamera 903-06			PR:-193 -"J.."
1	970 044 900 32	Wire set Mobile Hands-free equipment only in conj. with: PCM 3.1 or CDR PLUS Coding VIA PRMS		1	PR:-619,-193 -"J.."

Model: TEQ 3

Model life 2010>>



Model: TEQ 3 Model life 2010>>

Pos	Part Number	Description	Remark	Qty	Model
-		Internet access D - MJ 2010>> - MJ 2016 Inst. & Conv. Instructions Panamera Group 9 9121 (5/11) 9121 (44/14) Attention			alle Pos. 1 Pos. 2
1	970 044 900 47	Parts kit Internet access		1	"J..", "AUS", "ZA.", "PME", "MEX", "ROK", "SGP"
1	970 044 900 48	Parts kit Internet access		1	-"J..", -"AUS", -"ZA.", -"PME", -"MEX", -"ROK", -"SGP"
-	970 044 900 45	repair set for Internet access 970 044 900 47 970 044 900 48		1	
-		Set comprising:			
-		Wire set		1	
-		Assembly kit		1	
-		Aerial		1	
-		Operating instructions		1	
-		Only for replacement			
2	95B 044 900 20	Parts kit Internet access Discontinued part		1	LTE -"USA", -"CN."
-	95B 044 900 25	repair set for Internet access 95B 044 900 20		1	LTE -"USA", -"CN."

Model: TEQ 3

Model life 2010>>

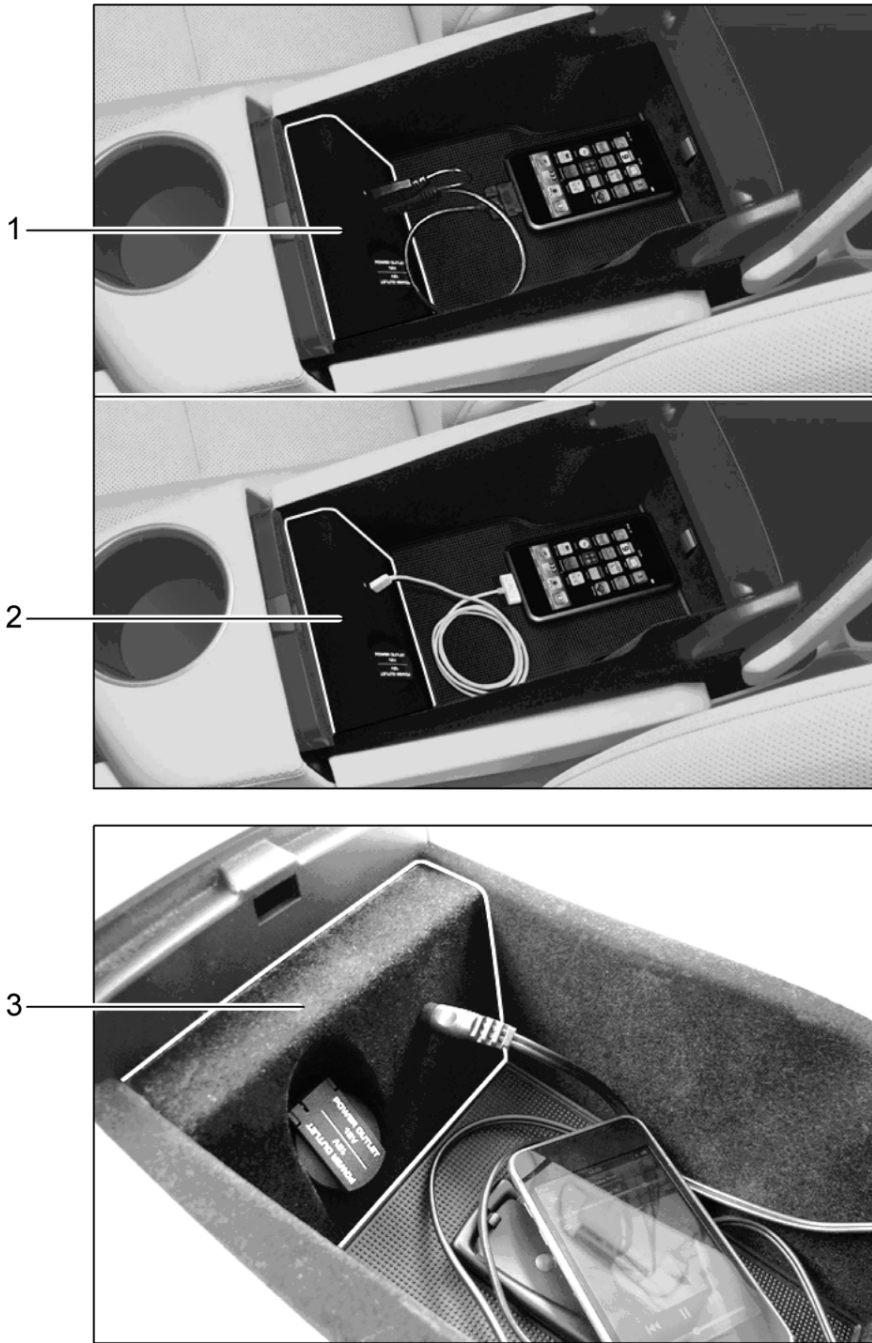

Model: TEQ 3 Model life 2010>>

Pos	Part Number	Description	Remark	Qty	Model
-		Multimedia interface Console Inst. & Conv. Instructions Panamera Group 9 9122 (17/09) 9122 (22/13) Attention	10-16		alle
1	970 044 900 34	Multimedia interface Universal only in conj. with: PCM3.1 Until Vehicle Ident. No. F >> 97-AL045 689 F >> 97-AL082 883 Coding VIA PRMS	10-10	1	PR:672 S / 4S Turbo
2	970 044 900 43	Multimedia interface Universal only in conj. with: PCM3.1 From Vehicle Ident. No. F 97-AL045 690>> F 97-AL082 884>> or PCM3.1 TEQUIPMENT 970.044.900.9X Coding VIA PRMS	10-13	1	PR:672 S / 4S Turbo
(2)	970 044 901 34	Multimedia interface Universal only in conj. with: PCM3.1 Coding VIA PRMS	14-16	1	PR:672
-		Inst. & Conv. Instructions Panamera Group 9 9122 (2/10) 9122 (23/13) Attention			alle
3	970 044 900 39	Multimedia interface Universal only in conj. with: CDR31 Coding VIA PRMS	10-13	1	PR:696
(3)	970 044 901 39	Multimedia interface Universal only in conj. with: CDR31	14-16	1	PR:696

Model: TEQ 3

Model life 2010>>

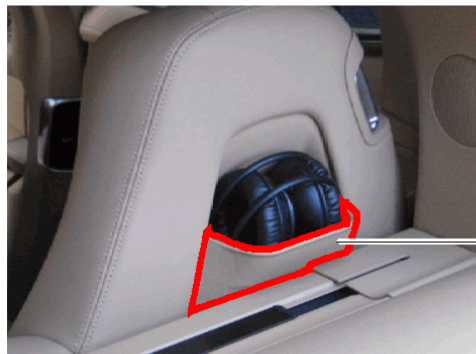
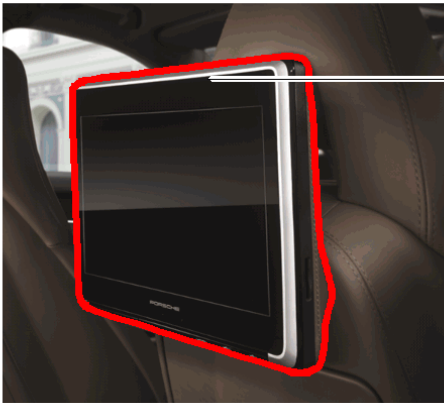

Model: TEQ 3 Model life 2010>>

Pos	Part Number	Description	Remark	Qty	Model
-		Rear seat entertainment system Exclusive programme Spare parts catalogue Inst. & Conv. Instructions	10- 17-		
(1)	971 044 920 A	Panamera Group 9 9194 (04/17) Attention Retrofit kit Rear seat entertainment system Software use if required:	18- 970 558 316 00	1	Cluster 8 PR:9WU -"CN.", -"PAP", -"MEX", -"BR.", -"ROK", -"IND", -"KAR"
(1)	971 044 921 A	Retrofit kit Rear seat entertainment system Software use if required:	18- 970 558 316 00	1	Cluster 8 PR:9WU "CN.", -"PAP", -"MEX", -"BR.", -"ROK", -"IND", -"KAR"
-		Only for replacement Exclusive programme Order			
-		Inst. & Conv. Instructions Panamera Group 9 Exchange Screen 9194 (20/15) Subsequent installation (complete) 9194 (25/15) Attention	14-16		
2	970 558 320 00	DVD-player Rear seat entertainment system	14-16 painted	1	
(2)	970 558 321 00	Black DVD-player Rear seat entertainment system Leather paint	14-16	1	
	970 558 321 00 6G0	Leather colour/crema			
	970 558 321 00 8C0	Leather colour/espresso			
	970 558 321 00 8M8	Leather colour/marsala red			
	970 558 321 00 8YR	Leather colour/black			
	970 558 321 00 9EF	Leather colour/cognac			
	970 558 321 00 9H6	Leather colour/luxor beige			
	970 558 321 00 N11	Leather colour/garnet red/ Carrera red			
	970 558 321 00 OD2	Leather colour/ agatha chestnut brown			
	970 558 321 00 OK6	Leather colour/saddle brown			
	970 558 321 00 PL1	Leather colour/agate grey			
	970 558 321 00 HAT	Leather colour/black/			

Model: TEQ 3 Model life 2010>>

Pos	Part Number	Description	Remark	Qty	Model
(2)	970 558 322 00	Carrera red DVD-player Rear Seat Entertainm. Plus	14-16 painted	1	
(2)	970 558 323 00	Black DVD-player Rear Seat Entertainm. Plus Leather paint	14-16	1	
	970 558 323 00 6G0	Leather colour/crema			
	970 558 323 00 8C0	Leather colour/espresso			
	970 558 323 00 8M8	Leather colour/marsala red			
	970 558 323 00 8YR	Leather colour/black			
	970 558 323 00 9EF	Leather colour/cognac			
	970 558 323 00 9H6	Leather colour/luxor beige			
	970 558 323 00 N11	Leather colour/garnet red/ Carrera red			
	970 558 323 00 OD2	Leather colour/ agatha chestnut brown			
	970 558 323 00 OK6	Leather colour/saddle brown			
	970 558 323 00 PL1	Leather colour/agate grey			
	970 558 323 00 HAT	Leather colour/black/ Carrera red			
-	970 044 901 00	Retrofit kit Rear seat entertainment system New design comprising: DVD device Operating instructions only in conj. with:	10-16	1	PR:XEP
		Headphones		2	
		Bluetooth		1	
3	970 558 316 00	Headphones Bluetooth	10-	1	
-	970 558 314 00	Operating instructions Rear seat entertainment system Valid for 970 558 320 00 970 558 321 00 970 558 322 00 970 558 323 00	14-16	1	
-		Inst. & Conv. Instructions Panamera Group 9 9194 (42/10) Attention	10-16		
4	970 645 991 00	DVD-player Leather paint	10-13	1	PR:-890,-891
	970 645 991 00 HAT	Leather colour/black/ Carrera red			
	970 645 991 00 6G0	Leather colour/crema			
	970 645 991 00 6U7	Leather colour/yachting blue			
	970 645 991 00 7A0	Leather colour/platinum grey			
	970 645 991 00 7MP	Leather colour/cedar			
	970 645 991 00 8C0	Leather colour/espresso			
	970 645 991 00 8M8	Leather colour/marsala red			
	970 645 991 00 8YR	Leather colour/black			
	970 645 991 00 9EF	Leather colour/cognac			
	970 645 991 00 9H6	Leather colour/luxor beige			
(4)	970 645 991 01	DVD-player Together with Folding table Leather paint	14-16	1	PR:890,891
	970 645 991 01 N11	Leather colour/Carrera red			

Model: TEQ 3 Model life 2010>>

Pos	Part Number	Description	Remark	Qty	Model
	970 645 991 01 PL1	Leather colour/agate grey			
	970 645 991 01 6G0	Leather colour/crema			
	970 645 991 01 6U7	Leather colour/yachting blue			
	970 645 991 01 7A0	Leather colour/platinum grey			
	970 645 991 01 7MP	Leather colour/cedar			
	970 645 991 01 8C0	Leather colour/espresso			
	970 645 991 01 8M8	Leather colour/marsala red			
	970 645 991 01 8YR	Leather colour/black			
	970 645 991 01 9EF	Leather colour/cognac			
	970 645 991 01 9H6	Leather colour/luxor beige			
5	970 645 993 00	Receiver (complete)	10-16	1	
6	970 645 994 00	Rear seat entertainment system Receiver Cup in Interior colour	10-16	1	
	970 645 994 00 6G0	Cream			
	970 645 994 00 6U7	yachting blue			
	970 645 994 00 7A0	Platinum Grey			
	970 645 994 00 7MP	Cedar			
	970 645 994 00 8C0	Espresso			
	970 645 994 00 8M8	Marsala Red			
	970 645 994 00 8YR	Black			
	970 645 994 00 9EF	Cognac			
	970 645 994 00 9H6	Luxor beige			
-	970 645 996 00	Cable AUX Valid for 970 645 991 00 970 645 991 01	10-13	1	
-	970 645 992 00	Operating instructions Rear seat entertainment system Valid for 970 645 991 00 970 645 991 01	10-16	1	

Model: TEQ 3

Model life 2010>>

1

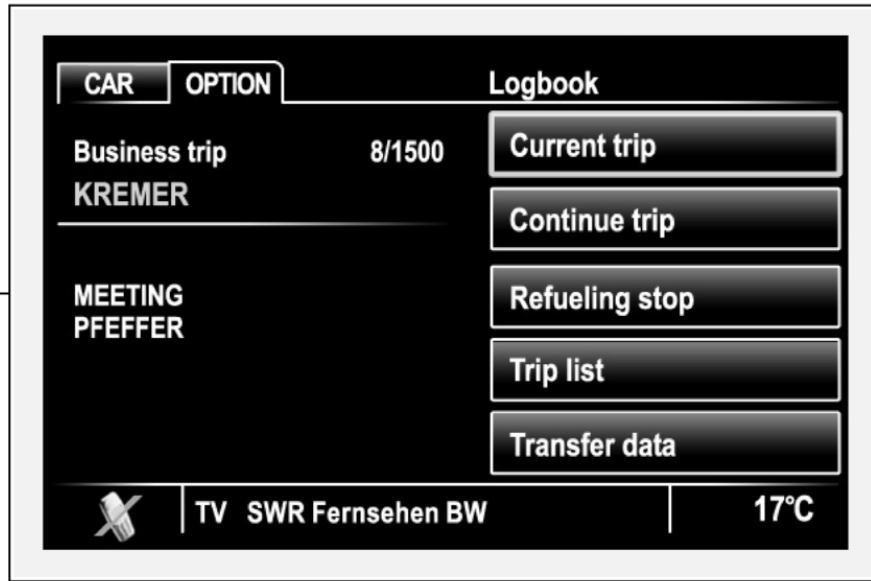

Model: TEQ 3

Model life 2010>>

Pos	Part Number	Description	Remark	Qty	Model
-		Logbook PCM3.1 D - MJ 2010>> - MJ 2016 Inst. & Conv. Instructions Panamera Group 9 9110 (19/09) beachten			alle
(1)	958 044 900 29	Logbook Coding VIA PRMS D - MJ 2010>> - MJ 2016 Discontinued part		1	PR:641

Model: TEQ 3

Model life 2010>>



Model: TEQ 3 Model life 2010>>

Pos	Part Number	Description	Remark	Qty	Model
-		Subsequent installation ONLINE SERVICES PCM3.1 D - MJ 2012>> - MJ 2016 Inst. & Conv. Instructions Panamera Group 9 9110 (37/13) Attention			
1	958 044 900 28	Software ONLINE SERVICES only in conj. with: PCM3.1 Coding VIA PRMS D >> - MJ 2016		1	45/2012 >>